

**Training
Aids for
Dam
Safety**

MODULE:

**INSPECTION OF
CONCRETE AND
MASONRY DAMS**

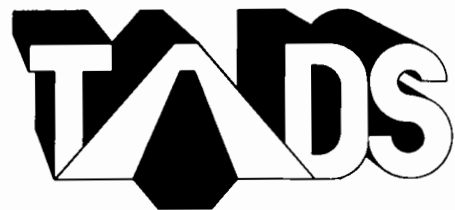

A video presentation accompanies this workbook.

Trainning **A**ids for **D**am **S**afety

MODULE:

INSPECTION OF CONCRETE AND MASONRY DAMS

Subject-Matter-Expert Panel

Ralph O. Atkinson
Bureau of Reclamation,
Chairman

Jerry T. Chastain
Federal Energy Regulatory
Commission

Samuel M. Huston
Tennessee Valley Authority

Edward Lofton
Corps of Engineers

PREFACE

There are presently more than 80,000 dams in use across the United States. Like any engineering works, these dams require continual care and maintenance, first to ensure that they remain operational and capable of performing all intended purposes, and then to preclude endangering people and property downstream.

The safety of all dams in the United States is of considerable national, state, and local concern. Given that, the principal purpose of the TADS (Training Aids for Dam Safety) program is to enhance dam safety on a national scale. Federal agencies have responsibility for the safe operation, maintenance, and regulation of dams under their ownership or jurisdiction. The states, other public jurisdictions, and private owners have responsibility for the safety of non-Federal dams. The safety and proper custodial care of dams can be achieved only through an awareness and acceptance of owner and operator responsibility, and through the availability of competent, well-trained engineers, geologists, technicians, and operators. Such awareness and expertise are best attained and maintained through effective training in dam safety technology.

Accordingly, an ad hoc Interagency Steering Committee was established to address ways to overcome the paucity of good dam safety training materials. The committee proposed a program of self-instructional study embodying video and printed materials and having the advantages of wide availability/marketability, low per-student cost, limited or no professional trainer involvement, and a common approach to dam safety practices.

The 14 Federal agencies represented on the National Interagency Committee on Dam Safety fully endorsed the proposed TADS program and have underwritten the cost of development. They have also made available technical specialists in a variety of disciplines to help in preparing the instructional materials. The states, through the Association of State Dam Safety Officials, also resolved to support TADS development by providing technical expertise.

The dam safety instruction provided by TADS is applicable to dams of all sizes and types, and is useful to all agencies and dam owners. The guidance in dam safety practice provided by TADS is generally applicable to all situations. However, it is recognized that the degree to which the methods and principles are adopted will rest with the individual agency, dam owner, or user. The sponsoring agencies of TADS assume no responsibility for the manner in which these instructional materials are used or interpreted, or the results derived therefrom.

ACKNOWLEDGMENTS

TADS STEERING COMMITTEE

James R. Graham, Bureau of Reclamation, Chairman
Arthur H. Walz, Corps of Engineers
William S. Bivins, Federal Emergency Management Agency
Donald L. Basinger, Soil Conservation Service
Joseph J. Ellam, Association of State Dam Safety Officials
(Commonwealth of Pennsylvania)
Marshall L. Silver, U.S. Committee on Large Dams

TADS PROJECT MANAGER

Chris J. Veesaert, Bureau of Reclamation

TADS TECHNICAL ACTIVITIES COMMITTEE

Robert L. James, Corps of Engineers, Chairman
Norman Miller, Soil Conservation Service, Vice Chairman
Chris J. Veesaert, Bureau of Reclamation
Harold C. Buttrey, Tennessee Valley Authority
Constantine G. Tjoumas, Federal Energy Regulatory Commission
Alan E. Pearson, Association of State Dam Safety Officials
(State of Colorado)

TADS SPONSORS (Representing the Interagency Committee on Dam Safety)

Bureau of Reclamation
Corps of Engineers
Federal Emergency Management Agency
Soil Conservation Service
Federal Energy Regulatory Commission
Tennessee Valley Authority
Forest Service
Bureau of Land Management
National Park Service
Bureau of Indian Affairs
Fish and Wildlife Service
Department of Energy
Nuclear Regulatory Commission
International Boundary and Water Commission

TADS SUPPORTING ORGANIZATIONS

Association of State Dam Safety Officials
U.S. Committee on Large Dams

INSPECTION OF CONCRETE AND MASONRY DAMS

TABLE OF CONTENTS

	<u>Page</u>
MODULE INTRODUCTION	i
UNIT I. INSPECTING THE DAM	
OVERVIEW	I-1
Introduction	I-1
Unit Objectives	I-1
CONCRETE AND MASONRY DAM FUNDAMENTALS	I-2
Introduction	I-2
Concrete Dam Characteristics	I-2
Types Of Concrete Dams	I-2
Gravity Dams	I-3
Buttress Dams	I-4
Arch Dams	I-5
Composite Dams	I-6
Masonry Dams	I-7
Concrete And Masonry Construction	I-7
Mass Concrete Construction	I-7
Roller-Compacted Concrete Construction	I-7
Masonry Construction	I-8
A Note On Terminology: Masonry Vs. Concrete	I-8
CONCRETE DAM FEATURES	I-9
Introduction	I-9
Principal Features	I-9
Reservoir	I-9
Crest	I-9
Faces	I-10
Heel And Toe	I-10
Abutments	I-10
Joints	I-10
Contraction Joints	I-10
Expansion Joints	I-11
Construction Joints	I-11
Interior Features	I-11
Gallery System	I-11
Drainage System	I-12
Water Conveyance Structures	I-15
Spillways	I-15
Outlet Works	I-16
Penstocks	I-16
Other Structures And Mechanical Equipment	I-16
Reference Conventions	I-16

Continued . . .

INSPECTION OF CONCRETE AND MASONRY DAMS

TABLE OF CONTENTS

	<u>Page</u>
CONCRETE DAM INSPECTION TECHNIQUES	I-17
Introduction	I-17
Preparing For Inspection	I-17
Reviewing Data	I-17
Talking With Personnel	I-17
Tools And Equipment	I-18
General Guidelines	I-19
Documenting And Reporting	I-20
Inspecting The Crest	I-20
Sighting Techniques For Straight Dams	I-20
Sighting Techniques For Arch Dams	I-22
Inspecting The Upstream Face	I-22
Underwater Inspections	I-22
Inspecting The Downstream Face	I-22
Inspecting Areas Downstream And Upstream Of The Dam	I-23
Inspecting The Dam Interior	I-24
UNIT EXERCISE	I-25
SUMMARY	I-33
 UNIT II. INSPECTING FOR DEFICIENCIES	
OVERVIEW	II-1
Introduction	II-1
Unit Objectives	II-1
CRACKING	II-2
What Is Cracking?	II-2
Characteristics Of Cracks	II-2
Length	II-2
Width	II-2
Direction	II-3
Depth	II-4
Trend	II-4
Location	II-5
Types Of Cracks	II-5
Structural Cracks	II-5
Cracks Along Joints	II-6
Shrinkage Cracks	II-7
Thermal Cracking	II-7
Pattern Cracking	II-7
D-Cracking	II-8
Other Shallow Cracking	II-9

Continued . . .

INSPECTION OF CONCRETE AND MASONRY DAMS

TABLE OF CONTENTS

	<u>Page</u>
CRACKING (Continued)	
Crack Surveys	II-9
Cracking: Inspection Actions	II-9
CONCRETE DETERIORATION	II-11
What Is Concrete Deterioration?	II-11
Types Of Deterioration	II-11
Disintegration	II-11
Spalling	II-11
Efflorescence	II-11
Drummy Concrete	II-12
Popouts	II-13
Pitting	II-13
Scaling	II-14
Causes Of Concrete Deterioration	II-14
Faulty Concrete Mixes	II-14
Chemical Attack	II-15
Metal Corrosion	II-16
Erosion	II-17
Cavitation	II-17
Surface Mapping	II-17
Concrete Deterioration: Inspection Actions	II-19
MASONRY DETERIORATION	II-20
Types Of Deterioration	II-20
Masonry Deterioration: Inspection Actions	II-20
SURFACE DEFECTS	II-21
What Are Surface Defects?	II-21
Types Of Surface Defects	II-21
Honeycomb	II-21
Stratification	II-22
Form Slippage	II-22
Stains	II-22
Impact Damage	II-23
Surface Defects: Inspection Actions	II-23
DISPLACEMENT	II-24
What Is Displacement?	II-24
Misalignment	II-24
Differential Movement	II-24
Detecting Displacement	II-25
Displacement: Inspection Actions	II-26

Continued . . .

INSPECTION OF CONCRETE AND MASONRY DAMS

TABLE OF CONTENTS

	<u>Page</u>
LEAKAGE AND SEEPAGE	II-27
What Are Leakage And Seepage?	II-27
Characteristics Of Leakage	II-27
Characteristics Of Seepage	II-27
Monitoring Leakage And Seepage	II-28
Turbidity	II-28
Taking Measurements	II-28
Blocked Drains	II-29
Leakage And Seepage: Inspection Actions	II-29
MAINTENANCE CONCERNS	II-30
What Are Maintenance Concerns?	II-30
Faulty Drainage	II-30
Faulty Drainage: Inspection Actions	II-30
Undesirable Vegetation	II-31
Undesirable Vegetation: Inspection Actions	II-31
Debris	II-31
Debris: Inspection Actions	II-31
Joint Condition	II-31
Joint Condition: Inspection Actions	II-31
Previous Repairs	II-32
Previous Repairs: Inspection Actions	II-32
Environmental Conditions	II-32
Environmental Conditions: Inspection Actions	II-33
UNIT EXERCISE	II-34
SUMMARY	II-44
Deficiencies To Look For	II-44
When To Get Further Assistance	II-46
Remember To "SMPL"	II-46
Video Presentation	II-47
FINAL REVIEW EXERCISE	I
APPENDIXES	
Appendix A: Glossary	A-1
Appendix B: References	B-1

INSPECTION OF CONCRETE AND MASONRY DAMS

LIST OF FIGURES AND TABLES

<u>FIGURE #</u>	<u>TITLE</u>	<u>Page</u>
I-1	Sectional View Of A Gravity Dam	I-3
I-2	Simplified View Of A Flat Slab Buttress Dam	I-4
I-3	Simplified View Of An Arch Dam	I-5
I-4	Composite Dam	I-6
I-5	Typical Concrete Dam	I-9
I-6	Portion Of A Gallery System For A Large Dam	I-12
I-7	Cross-Section Of Gallery Showing Location Of Typical Drains And Grout Curtain	I-14
I-8	Typical Water Conveyance Structures	I-15
I-9	Sighting Along The Crest	I-21
II-1	Determining Crack Width	II-3
II-2	Orientation Of Cracking	II-4
II-3	Structural Crack With Vertical Displacement	II-6
II-4	Pattern Cracking	II-7
II-5	D-Cracking	II-8
II-6	Drummy Concrete	II-12
II-7	Popouts	II-13
II-8	Pitting	II-13
II-9	Scaling	II-14
II-10	Concrete Deterioration Due To Metal Corrosion	II-16
II-11	Surface Mapping	II-18
II-12	Honeycomb	II-21
II-13	Stratification	II-22
II-14	Misalignment And Differential Movement	II-24
II-15	Transverse And Radial Displacement	II-25
 <u>TABLE #</u>		
I-1	Inspection Tools And Equipment	I-18

MODULE INTRODUCTION

INSPECTION OF CONCRETE AND MASONRY DAMS

MODULE INTRODUCTION

OVERVIEW OF THE MODULE

In this module, you will learn the recommended methods for inspecting concrete and masonry dams and for detecting deficiencies. You will learn about the specific deficiencies that may be present in a concrete or masonry dam and the impact these deficiencies can have on the safety of the dam. In addition, you will be provided with guidance on selecting the appropriate actions to be taken when deficiencies are observed.

OBJECTIVES

At the completion of this module, you will be able to:

- . Describe the characteristics of concrete and masonry dams.
- . Describe the different types of concrete dams.
- . Describe the different methods of concrete and masonry construction.
- . List the principal features of a concrete or masonry dam and describe the functions of each feature.
- . Identify the following types of deficiencies:
 - Cracking
 - Concrete deterioration
 - Disintegration
 - Spalling
 - Efflorescence
 - Drummy concrete
 - Popouts, pitting, and scaling
 - Chemical attack
 - Metal corrosion
 - Erosion
 - Surface defects
 - Honeycomb
 - Stratification
 - Form slippage
 - Stains
 - Impact damage
 - Displacement
 - Leakage and seepage

Continued . . .

INSPECTION OF CONCRETE AND MASONRY DAMS

MODULE INTRODUCTION

OBJECTIVES (Continued)

- Maintenance concerns
 - Faulty drainage
 - Undesirable vegetation
 - Debris
 - Joint condition
 - Previous repairs
 - Environmental conditions
- . Explain the potential consequences of each type of deficiency or concern.
- . Select the appropriate actions to take if deficiencies are observed.

HOW TO USE THIS MODULE

This module is designed to be used in conjunction with other Training Aids for Dam Safety (TADS) modules. The TADS Learner's Guide lists all of the TADS modules and presents a recommended sequence for completing the modules. You may want to review the Learner's Guide before completing this module.

Before completing this module, you may want to complete the Preparing To Conduct A Dam Safety Inspection module.

CONTENTS OF THIS MODULE

This module is divided into two units followed by two appendixes:

- . **Unit I. Inspecting The Dam:** Presents information on the types of concrete and masonry dams, concrete dam features, and concrete dam inspection techniques.
- . **Unit II. Inspecting For Deficiencies:** Provides instruction on identifying concrete dam deficiencies and selecting appropriate followup actions.
- . **Appendix A. Glossary:** Defines a number of technical terms used in this module.
- . **Appendix B. References:** Lists recommended references that can be used to supplement this module.

INSPECTION OF CONCRETE AND MASONRY DAMS

MODULE INTRODUCTION

DESIGN OF THIS MODULE

This module is a self-paced instructional package. You may move through it as slowly or as rapidly as is comfortable for you. You may stop and review the material at any time. Since the module is designed for independent study, you may take breaks whenever you wish.

There are several components of this module that are designed to help you master the material being presented. These components include:

- . Text Instruction
- . Unit Exercises
- . Video Presentations
- . Final Review Exercise

We will now look at how you will use each component individually.

Text Instruction

The text instruction is presented in this workbook. Always begin by reading the text instruction since it explains how to proceed through a given block of instruction.

As you read the text instruction, you will notice that every page has a header. The header is designed to let you know where you are in the module. Let's look at how information is presented in the header.

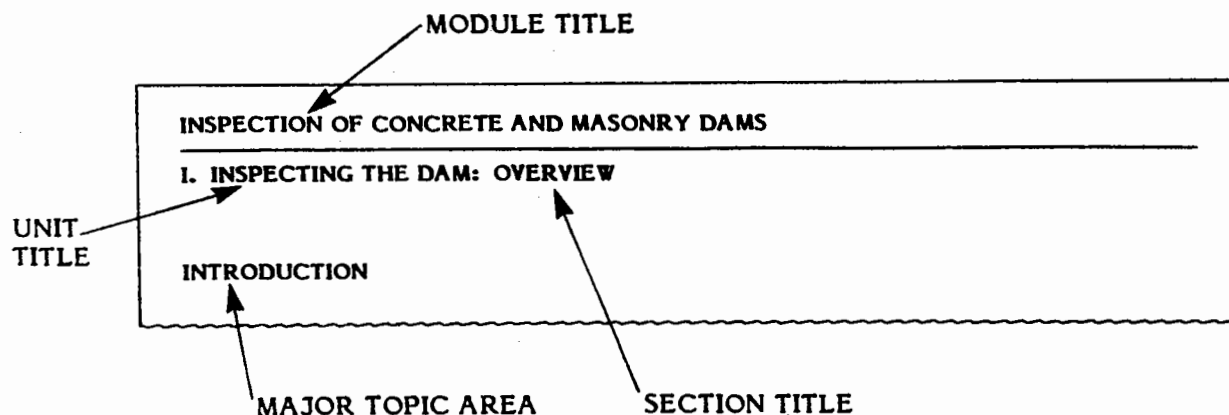

Unit Exercises

Most units include exercises to help you determine how well you are mastering the information presented. These exercises are **not** tests and will not be used to grade you or to rate your performance. Rather, the exercises are tools to help you assess your own learning.

Instructions for completing the exercises appear at the beginning of every exercise. Answers to the exercises are presented immediately following each exercise.

INSPECTION OF CONCRETE AND MASONRY DAMS

MODULE INTRODUCTION

Video Presentations

One video presentation is included in this module. The text will tell you when to watch the video presentation. After viewing the video presentation, return to the text. You may watch the video presentation as many times as you find helpful.

Final Review Exercise

After reading the text instruction and watching the video segments, you will complete a final review exercise. The final review exercise is designed to help you determine how much you have learned from the module. The final review exercise will not be used to grade you or to judge your performance.

Instructions for completing the final review exercise are presented at the beginning of the exercise. After completing the final review exercise, check your answers against those presented in the answer key. The answer key is located immediately after the final review exercise.

If you miss several of the questions, you may want to review the page numbers or video segments referenced in the answer key. If you get most of the questions correct, you are ready to begin another module.

REQUIRED MATERIALS

To complete this module, you will need the following materials:

- . This workbook and a pencil or pen
- . The accompanying videocassette and a videotape player

You may want to find a quiet place to work while you study these materials.

UNIT I
INSPECTING THE DAM

INSPECTION OF CONCRETE AND MASONRY DAMS

I. INSPECTING THE DAM: OVERVIEW

INTRODUCTION

This first unit of the Inspection Of Concrete And Masonry Dams module will introduce you to . . .

- . Concrete and masonry dam fundamentals
 - . Dam characteristics
 - . Types of concrete dams
 - . Masonry dams
- . Concrete and masonry construction
- . Concrete dam features
- . Concrete dam inspection techniques

If you are new to dam safety inspection, the material presented in this unit will give you important background information. The discussion of inspection techniques is designed to provide you with basic guidelines for conducting a comprehensive inspection of a concrete or masonry dam.

If you have experience with concrete and masonry dams, this unit will serve as a brief refresher on key terminology used in concrete and masonry dam inspection. Since terminology may differ from one agency to another, you may find it helpful to review this section to become familiar with the way terms are used in this module.

UNIT OBJECTIVES

After completing this unit, you will be able to . . .

- . Describe the characteristics of concrete and masonry dams.
- . Describe the different types of concrete dams.
- . List the principal features of a concrete or masonry dam and describe the functions of each feature.
- . Describe the procedures for inspecting the crest, upstream and downstream faces, interior, and areas upstream and downstream of the dam.

INSPECTION OF CONCRETE AND MASONRY DAMS

I. INSPECTING THE DAM: CONCRETE AND MASONRY DAM FUNDAMENTALS

INTRODUCTION

This section provides background information on the characteristics and types of concrete and masonry dams. Different types of dams vary in how they respond to different types of stresses. It will be helpful to you, as an inspector, to have a basic understanding of how concrete and masonry dams are designed and constructed, how they react to forces, and how deficiencies relate to structural type.

CONCRETE DAM CHARACTERISTICS

A concrete dam is defined as a dam constructed mainly of cast-in-place or roller-compacted concrete.

Concrete dams are thinner than embankment dams and impose more concentrated loads on the foundation and abutments. A narrow canyon with an adequate rock foundation is a typical site for concrete dams, which require a solid foundation that is relatively free of faults, shears, and major changes in foundation strength. Such discontinuities can overstress the concrete by causing some areas of the dam to carry more load than other areas. That is, by causing an unequal distribution of imposed loads, weak areas of the foundation carry less load, while projections cause more load to be carried locally.

Although people tend to think of concrete dams as more permanent structures than embankment dams, failure of a concrete dam is often more catastrophic. Because they have less obvious symptoms prior to failure, collapse may be very rapid, with little or no advance warning. Concrete dams are nearly immune to the kinds of failure that affect embankment dams, such as erosion during overtopping, embankment slides, and piping failures. Concrete dam failures, by contrast, usually fall into one of the following categories:

- . Overturning or sliding, resulting from erosion of the supporting foundation and/or abutments.
- . Overtopping, resulting from inadequate freeboard.
- . Abutment or foundation failure due to overstressing.
- . Structural failure of concrete unable to sustain imposed loads.

TYPES OF CONCRETE DAMS

There are three basic structural types of concrete dams: gravity, buttress, and arch. In addition, gravity or buttress dams are sometimes built as composite dams, with embankment sections flanking the concrete portion of the dam.

INSPECTION OF CONCRETE AND MASONRY DAMS

I. INSPECTING THE DAM: CONCRETE AND MASONRY DAM FUNDAMENTALS

Gravity Dams

Gravity dams are the most common type of concrete dam and the simplest to design and build. Massive and roughly triangular in cross-section, they depend on their weight and shape to withstand reservoir loads and transfer the loads to the foundation. In gravity dams, seepage uplift pressures are a concern because they can lead to an overturning or sliding failure. Figure I-1 shows a sectional view of a gravity dam.

FIGURE I-1. SECTIONAL VIEW OF A GRAVITY DAM

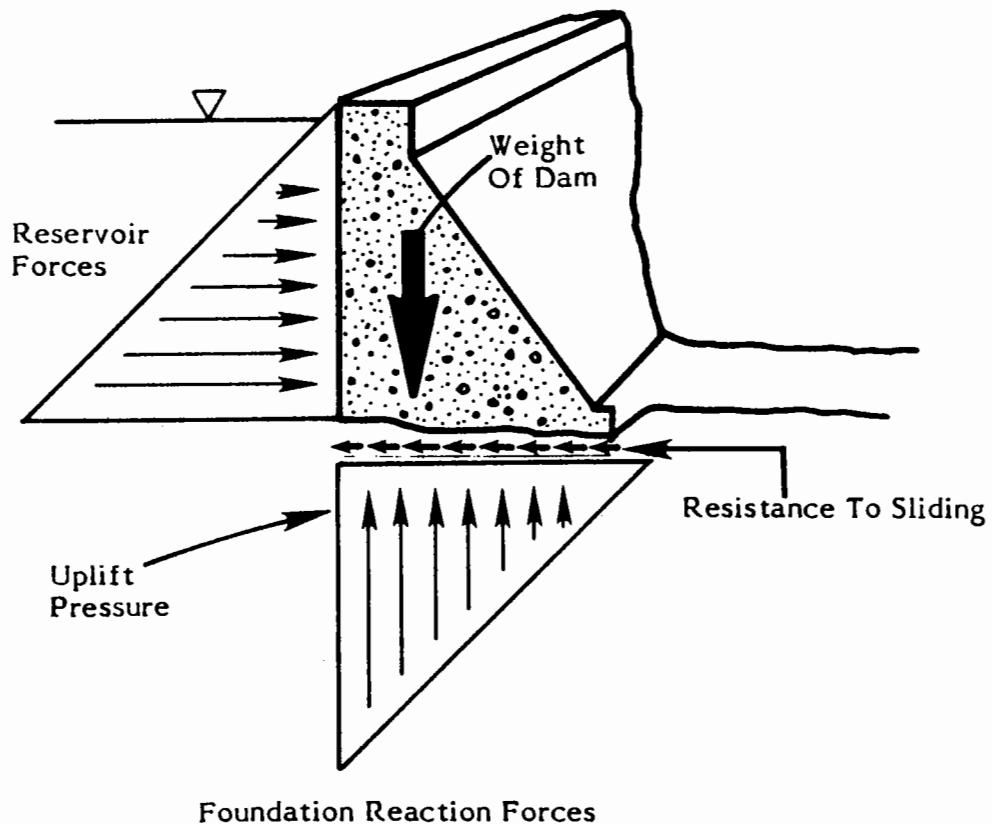

INSPECTION OF CONCRETE AND MASONRY DAMS

I. INSPECTING THE DAM: CONCRETE AND MASONRY DAM FUNDAMENTALS

Buttress Dams

Buttress dams, a form of gravity dam, depend on their own weight and the weight of the water to maintain stability. They are comprised of two basic structural elements: a watertight upstream face and a series of buttresses, or vertical walls, that support the face and transfer the load from the face to the foundation.

One type of buttress dam, as shown in a simplified manner in Figure I-2, is the flat-slab buttress dam, in which the upstream face is a relatively thin slab of reinforced concrete. Configurations vary, however, and you may encounter buttress dams with arched slabs or other configurations.

Buttress dams are a sensitive type of dam. The thin slab carries the reservoir load into the buttresses. Deficiencies in the design or condition of the slab can thus lead to instantaneous failure. Underseepage is also a concern because of the relatively thin base width across which reservoir head must be dissipated.

FIGURE I-2. SIMPLIFIED VIEW OF A FLAT SLAB BUTTRESS DAM

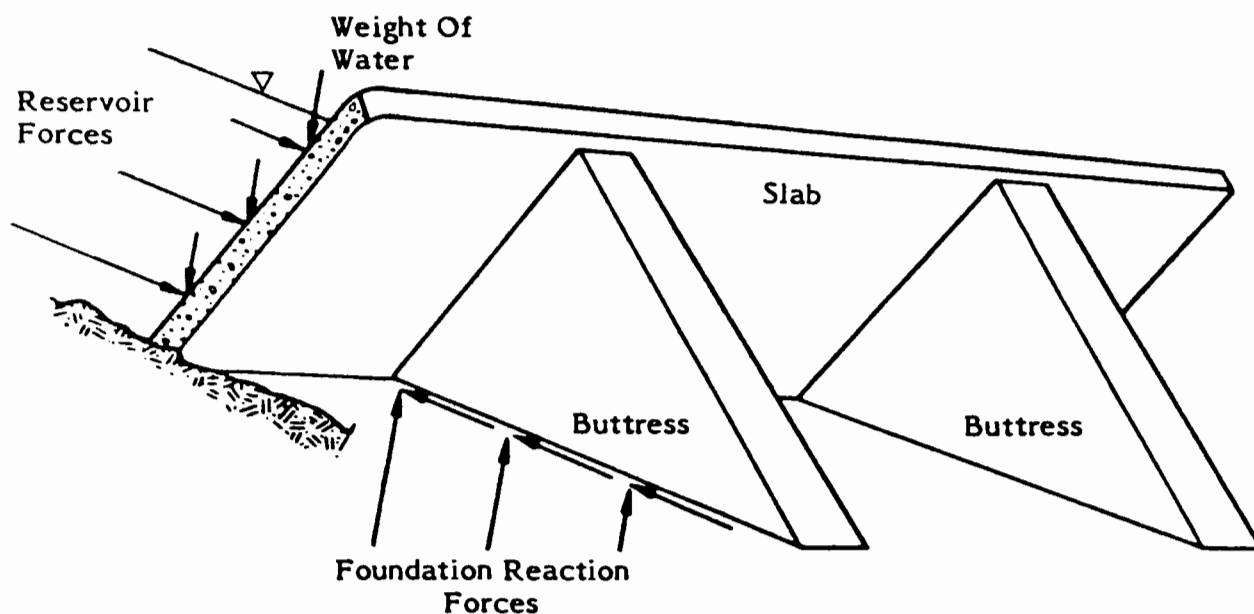

Although buttress dams require less concrete than gravity dams, their construction requires considerable labor to build the formwork. A number of buttress dams were built in the 1930's when the ratio of labor cost to materials cost was comparatively low. Construction of buttress dams has declined over the years as labor costs have risen.

INSPECTION OF CONCRETE AND MASONRY DAMS

I. INSPECTING THE DAM: CONCRETE AND MASONRY DAM FUNDAMENTALS

Arch Dams

An arch dam is a solid concrete dam that is arched upstream and normally is thinner than a gravity dam. Although arch dams transfer a small part of the reservoir load by their own weight into the foundation, they obtain most of their stability by transmitting the reservoir load into the canyon walls by arch action. Because arch dams are thin, overstressing of the concrete is a more critical factor in the safety of the dam. Underseepage, again, is a concern because of the relatively narrow base width. Figure I-3 shows a simplified view of an arch dam.

FIGURE I-3. SIMPLIFIED VIEW OF AN ARCH DAM

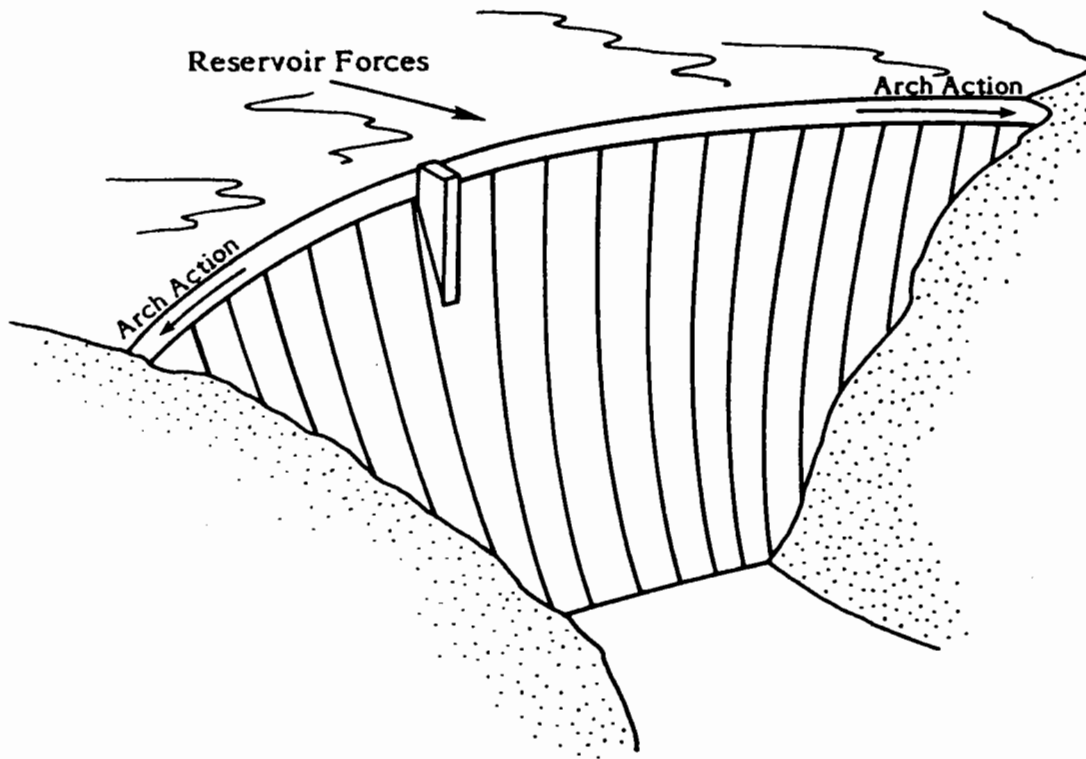

INSPECTION OF CONCRETE AND MASONRY DAMS

I. INSPECTING THE DAM: CONCRETE AND MASONRY DAM FUNDAMENTALS

Composite Dams

A composite dam generally consists of a concrete gravity or buttress section in combination with earthfill or rockfill embankment sections. Composite dams incorporate the advantages of a concrete dam--the ability to act as the spillway (that is, to be safely overtopped)--with the advantages of an embankment dam--low construction costs and the use of locally available construction materials. Figure I-4 shows an example of a composite dam.

FIGURE I-4. COMPOSITE DAM

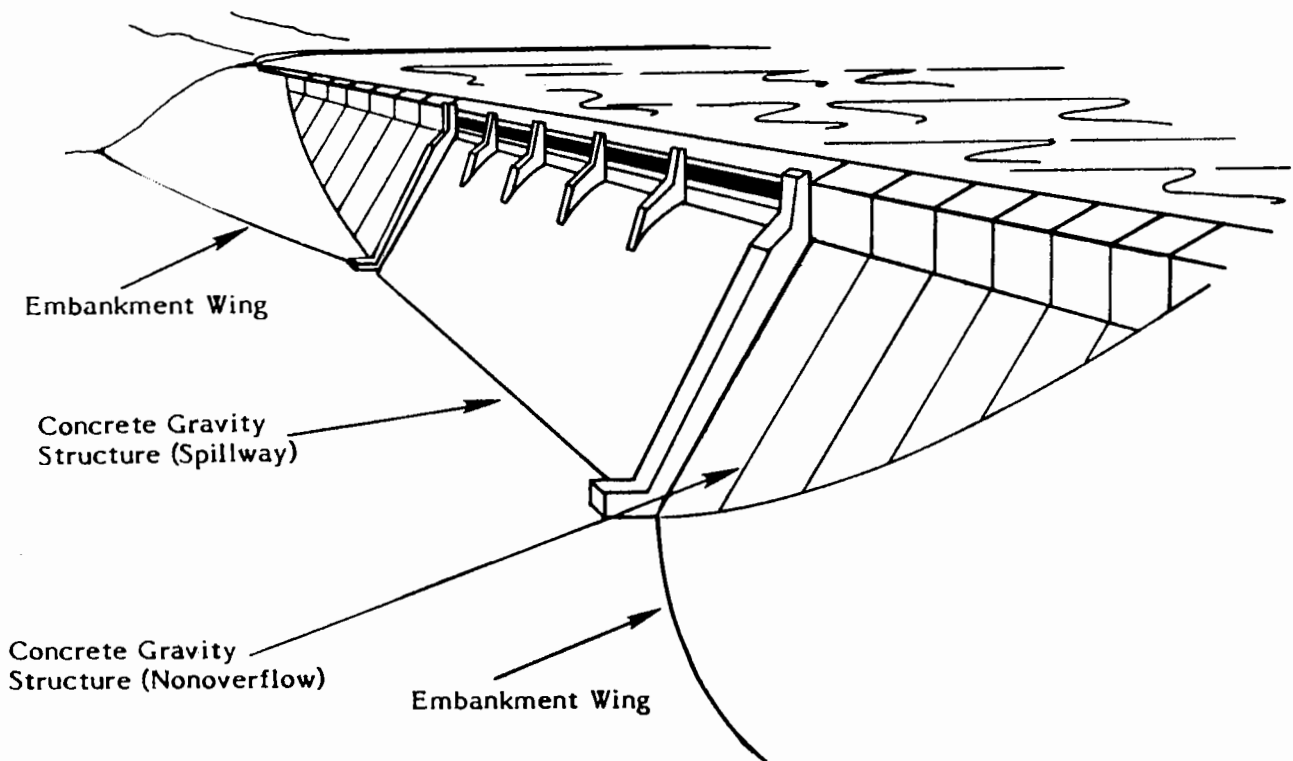

INSPECTION OF CONCRETE AND MASONRY DAMS

I. INSPECTING THE DAM: CONCRETE AND MASONRY DAM FUNDAMENTALS

MASONRY DAMS

A masonry dam is a dam constructed mainly of stone, brick, rock, or concrete blocks joined with mortar. Most masonry dams are older gravity dams, although a few are arch dams. The majority of deficiencies in masonry dams are similar to those in a concrete dam except that a major source of problems in masonry dams is deterioration of the mortar used in construction.

Masonry dams may be categorized by the type of stone embedded in mortar or concrete. For example, a masonry dam made with very large, irregularly shaped stone (known as "cyclopean stone") is called a cyclopean masonry dam. Embankment dams with only a masonry facing are not considered masonry dams. Masonry dams are no longer built because of recent advances in concrete technology and their relatively high cost of construction.

CONCRETE AND MASONRY CONSTRUCTION

Concrete dams are constructed by two different methods: mass concrete construction and roller-compacted concrete construction.

Mass Concrete Construction

Concrete is composed of sand, gravel, crushed rock, or other aggregates held together by a hardened paste of cement and water. The thoroughly mixed ingredients, when properly proportioned, make a plastic mass that can be cast or molded into a desired shape and size. Chemicals or additives are sometimes used in the mixture to enhance some characteristic of the concrete, such as workability or shrinkage control.

The large volume of concrete used in construction of a dam is commonly referred to as **mass concrete**. Concrete dams are built in very large blocks, or **monoliths**, by placing large quantities of concrete into preset forms and consolidating the concrete by means of vibration. After the concrete cures, the forms are stripped away and used in constructing other blocks. The temperature of the concrete may be controlled during curing by means of sizing of monoliths, mix design of concrete, and water spraying in curing. In cases of very large masses, cooling coils may be embedded in the concrete to minimize volumetric changes that lead to cracking.

Roller-Compacted Concrete Construction

Roller-compacted concrete (RCC) has been used in the construction of some newer dams and other types of structures and is potentially useful for repair work on existing dams. Using this method, a mixture of well-graded gravel and sand with low cement content is placed in layers and compacted using heavy equipment. Because of the construction technique (similar to that used in embankment construction), the horizontal construction joints on RCC dams are significantly closer together than those in a mass concrete dam. RCC dams may or may not contain vertical transverse construction joints.

INSPECTION OF CONCRETE AND MASONRY DAMS

I. INSPECTING THE DAM: CONCRETE AND MASONRY DAM FUNDAMENTALS

Masonry Construction

Masonry dams are constructed of stone, brick, rock, or concrete block joined with mortar. Generally speaking, two methods were used in constructing masonry dams: placing shaped blocks of stone with mortar in the joints between them, and binding various sizes of rock or concrete together with mortar.

A Note On Terminology: Masonry Vs. Concrete

Masonry dams are usually gravity dams, in which mortar is used to bind the blocks together. Failure of masonry dams often relates to deterioration of the mortar. It should be noted that masonry dams are far less common than concrete dams. Of the concrete/masonry dams you will encounter, the great majority are likely to be concrete dams. Nonetheless, procedures for inspecting concrete dams generally apply to masonry dams as well.

With these points in mind, we can now simplify the discussion through the remainder of this module and refer simply to concrete dams. You should assume, unless otherwise stated, that **references to concrete dams include both concrete and masonry dams.**

INSPECTION OF CONCRETE AND MASONRY DAMS

I. INSPECTING THE DAM: CONCRETE DAM FEATURES

INTRODUCTION

This section presents information on the typical features of a concrete (or masonry) dam, including principal features, joints, interior features, water conveyance structures, other structures, and mechanical equipment. Figure I-5 shows some of the externally visible features of a concrete dam. You may wish to refer to this figure during subsequent discussions.

FIGURE I-5. TYPICAL CONCRETE DAM

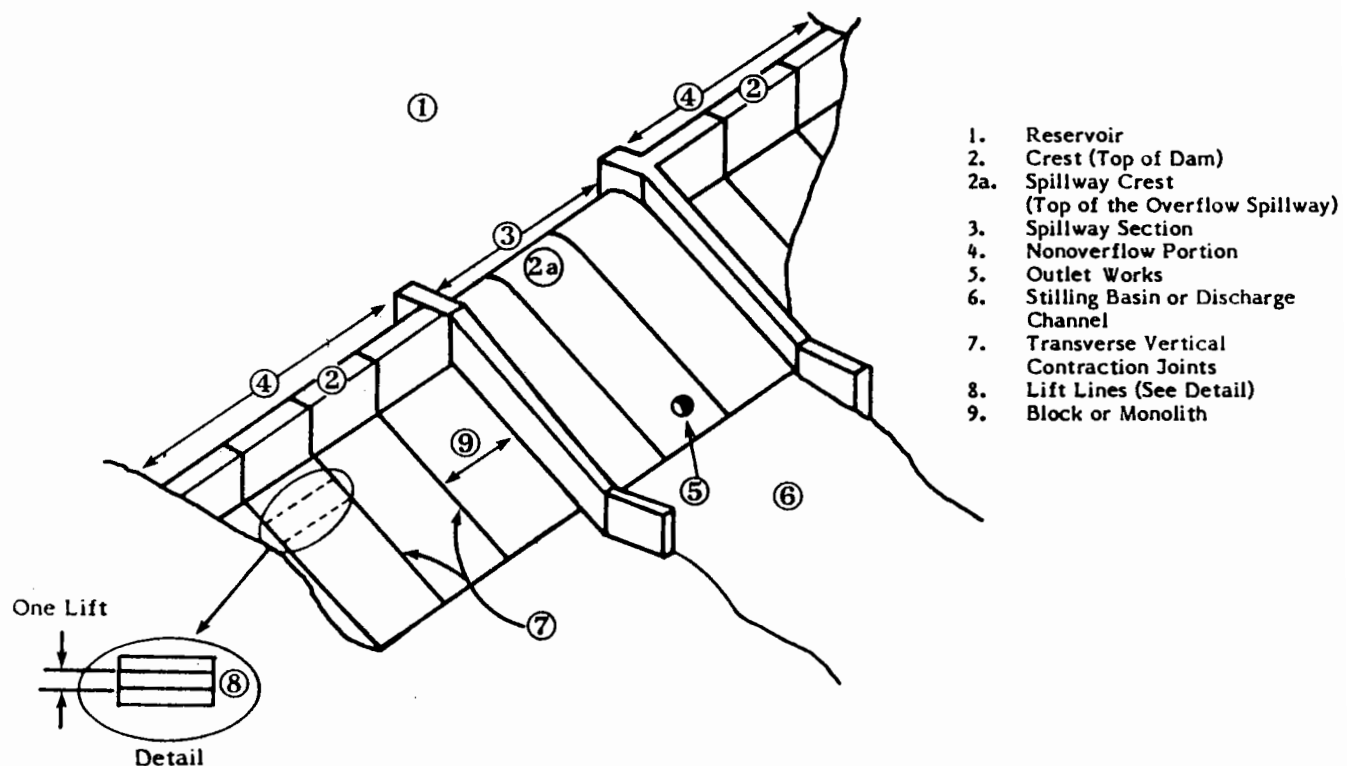

PRINCIPAL FEATURES

Reservoir

The **reservoir** is the body of water impounded by the dam.

Crest

The **crest** is the top surface of the dam or high point of the spillway control section. Often a roadway runs across the crest to accommodate traffic or to facilitate inspection, maintenance, or operation of machinery. Note that the spillway crest is lower than the crest on the nonoverflow portion of the dam.

INSPECTION OF CONCRETE AND MASONRY DAMS

I. INSPECTING THE DAM: CONCRETE DAM FEATURES

Faces

The **upstream face** is the inclined surface of a concrete dam that is in contact with the reservoir. During normal operation, a large part of the upstream face is usually under water.

The **downstream face** is the inclined surface of a concrete dam that faces away from the reservoir.

Heel And Toe

The **heel** of the dam is the juncture of the upstream face of a concrete dam with the ground surface.

The **toe** of the dam is the juncture of the downstream face of the dam with the ground surface, also referred to as the **downstream toe**.

Abutments

The **abutments** are those portions of the valley sides to which the ends of the dam join, and also those portions beyond the dam that might present seepage or stability problems.

JOINTS

Most concrete structures have joints between sections. Some joints are simply a result of the construction process--of ending one concrete placement and beginning another. Others are created purposely to allow movement of the sections or to control random cracking of the concrete. Three main types of joints occur in the construction of a concrete dam: contraction joints, expansion joints, and construction joints.

Contraction Joints

The **monolith blocks** that comprise a mass concrete dam are separated by vertical joints running transversely through the structure, from the upstream face to the downstream face and from the foundation to the crest. These joints, called **contraction joints**, are designed to prevent the formation of tension cracks as the structure undergoes volumetric shrinkage due to temperature drop. Contraction joints are constructed so that no bond exists between the blocks separated by the joints.

The opening of these transverse contraction joints could provide passages through the dam that, unless sealed, would permit water to leak from the reservoir to the downstream face. To prevent leakage, **seals**, or **waterstops**, are embedded in the concrete across the joints near the upstream face during the original construction. The most common types of seals are made of polyvinyl chloride (PVC), metal, or rubber.

INSPECTION OF CONCRETE AND MASONRY DAMS

I. INSPECTING THE DAM: CONCRETE DAM FEATURES

Contraction Joints (Continued)

Contraction joints may be grouted and/or keyed to enhance the stability of the structure. Grouting involves forcing a mixture of Portland cement and water into the joints under pressure. The grout then binds the individual blocks together so that they act as a monolithic mass.

Expansion Joints

Expansion joints are placed in a concrete structure primarily to accommodate volumetric expansion due to temperature rise. These joints most commonly are found in parapets, powerplants, walls, and other appurtenant structures that are subject to expansion. Expansion joints may be left open or filled with a compressible joint filler to prevent stress or load transfer. If the joint is sealed, the seal prevents leakage through the joint.

Construction Joints

Mass concrete dams are constructed in vertical increments called **lifts**. Horizontal joints, called **lift lines** or **horizontal construction joints**, occur when new concrete is placed on a previous lift. Construction joints must be prepared and treated during construction to ensure bonding of successive lifts of concrete. The construction joints, usually 5 to 10 feet apart and extending completely across the dam at the same elevation, are visible on the downstream face of the dam and give the face a layered look. Sometimes other lines are created in the concrete by the formwork used in constructing the blocks. These lines are usually much closer together and should not be confused with construction joints.

INTERIOR FEATURES

Two main features in the interior of a concrete dam are the gallery system and the drainage system.

Gallery System

A **gallery** is a passageway in the body of a dam used for inspection, foundation grouting, and/or drainage. Galleries may run longitudinally or transversely, may be horizontal or on a slope, and serve a variety of purposes:

- . Access into the dam for operation, maintenance, observation, and inspection.
- . Paths for utility lines.
- . Sites for control equipment.
- . Drainageway for water within the dam.
- . Access for grouting the foundation and abutments.

Galleries contain drainage gutters in the floor, into which drains may empty. The gutters facilitate the flow and measurement of drainage water within the dam.

Continued . . .

INSPECTION OF CONCRETE AND MASONRY DAMS

I. INSPECTING THE DAM: CONCRETE DAM FEATURES

Gallery System (Continued)

An **adit** is a gallery that is used for entrance to a gallery system or that serves as a connecting passageway between galleries or other features in the dam.

Tunnels are sometimes constructed into the rock of the abutments off the gallery system to provide access for grouting, drainage, and inspection of abutment rock.

Figure I-6 shows a portion of a complex gallery system of a large dam.

FIGURE I-6. PORTION OF A GALLERY SYSTEM FOR A LARGE DAM

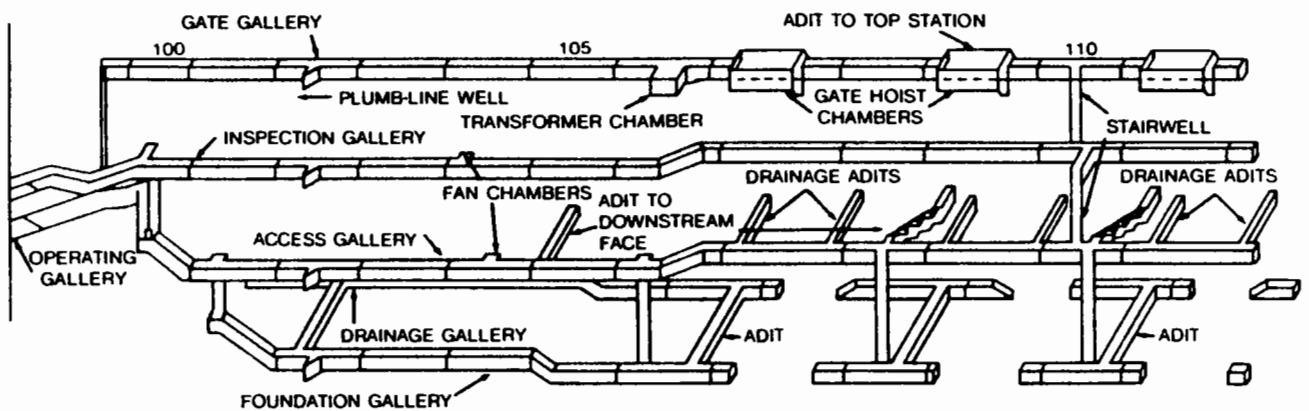

Drainage System

Water pressure from the reservoir (hydrostatic pressure) acts within a concrete dam as internal pressure in pores, cracks, joints, and seams. It also acts beneath a dam as uplift pressure. If uplift pressure is not controlled, it can cause instability of the dam. Hydrostatic pressure is monitored by uplift pressure gages placed in specially drilled holes or in selected existing drains. The operation and use of these gages and other instrumentation is discussed in the Instrumentation For Embankment And Concrete Dams module.

Continued . . .

INSPECTION OF CONCRETE AND MASONRY DAMS

I. INSPECTING THE DAM: CONCRETE DAM FEATURES

Drainage System (Continued)

A system of drains is used to control hydrostatic pressures by collecting and disposing of water that leaks into the structure or seeps through the foundation. There are three major types of drains:

- . Gallery drainage gutters
- . Formed drains (face drains and joint drains)
- . Foundation drains (drilled holes)

Gallery Drainage Gutters: The galleries are an integral part of the dam's drainage system. Galleries have floor gutters to carry away seepage or drainage entering the gallery. Pipes may be installed to collect water from the gutters and take it to lower elevations, where it eventually is discharged from the dam. Discharge is accomplished either through gravity flow or by pumping water collected in a sump.

Formed Drains: Formed drains, sometimes referred to as **face drains**, are vertical drain holes formed in the mass concrete during construction to intercept water that may leak into the dam along horizontal joints or through the concrete. Formed drains run vertically and usually are located about 10 or more feet from the upstream face on 10-foot centers. The tops of the drains normally extend to the crest of the dam, to facilitate inspection and cleaning. The lower ends either extend into a gallery system or are connected to a horizontal drain pipe that disposes of the water at the downstream face.

Foundation Drains: One method of controlling seepage under the dam is to construct a **grout curtain** in the foundation. A grout curtain is created by drilling one or more lines of holes deep in the foundation near the heel of the dam, and pumping grout into them. The grout fills voids in the foundation rock, creating a barrier to control seepage.

A grout curtain reduces but does not totally eliminate seepage through the foundation. To collect seepage that passes around or through the grout curtain, one or more lines of **foundation drains** usually are drilled into the foundation downstream of the grout curtain. By collecting the seepage water and discharging it through to the internal drainage system where it can be disposed of, the foundation drains reduce uplift pressure on the base of the dam and on horizontal failure planes within the foundation.

Foundation drain holes, usually drilled from foundation and drainage galleries and tunnels, are generally about 3 inches in diameter, 10 feet apart, and extend to depths of at least 20 to 40 percent of the reservoir depth and 35 to 75 percent of the grout curtain depth.

Figure I-7 shows the typical placement of a grout curtain and a line of foundation drains.

Continued . . .

INSPECTION OF CONCRETE AND MASONRY DAMS

I. INSPECTING THE DAM: CONCRETE DAM FEATURES

Drainage System (Continued)

FIGURE I-7. CROSS-SECTION OF GALLERY SHOWING LOCATION OF TYPICAL DRAINS AND GROUT CURTAIN (Elevation View)

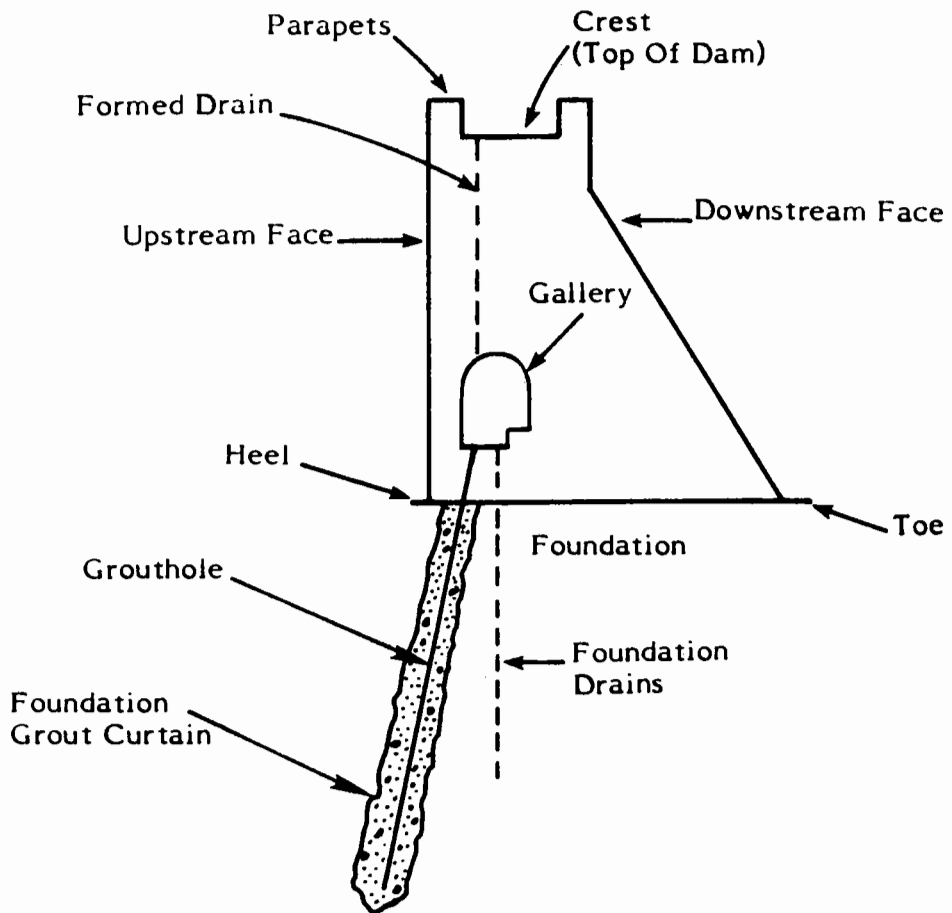

INSPECTION OF CONCRETE AND MASONRY DAMS

I. INSPECTING THE DAM: CONCRETE DAM FEATURES

WATER CONVEYANCE STRUCTURES

The passage of water through and around the dam is accomplished by **water conveyance structures**, including the spillways, outlet works, and penstocks. Figure I-8 illustrates a gated spillway and river outlet works.

FIGURE I-8. TYPICAL WATER CONVEYANCE STRUCTURES
(Elevation View)

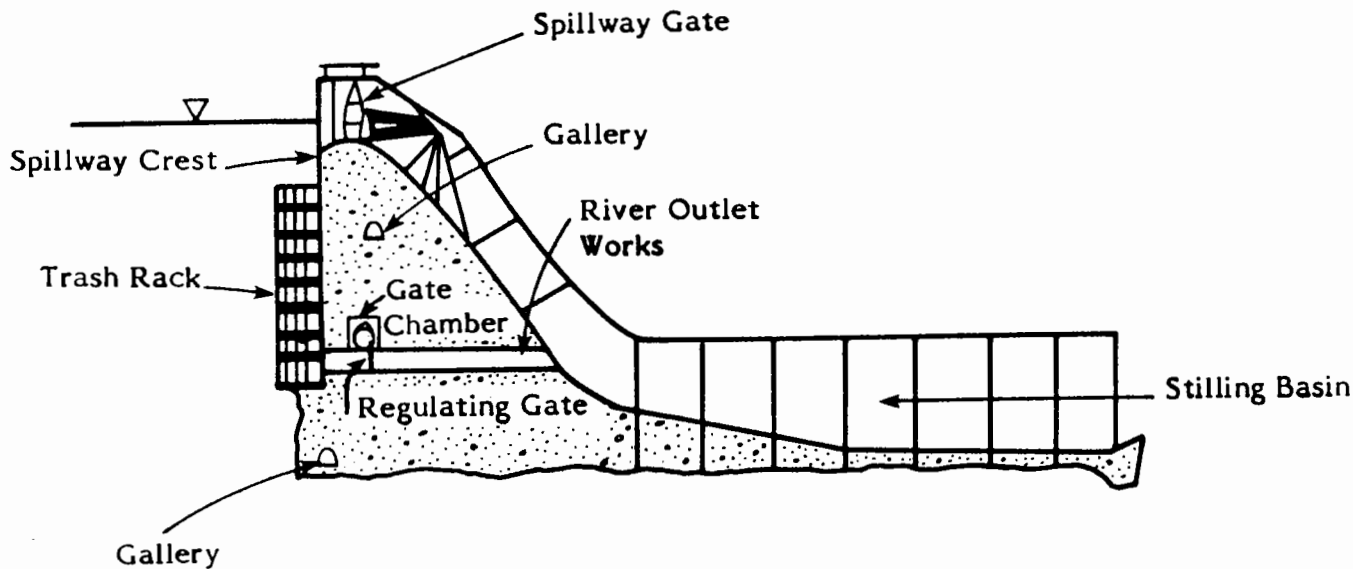

Spillways

The **spillway** is a structure over or through which flood flows are discharged from the reservoir--usually from the top of the reservoir. If the rate of flow is controlled by mechanical means, such as gates, the structure is considered a controlled spillway. If the elevation of the spillway crest is the only control, the structure is considered an uncontrolled spillway.

Water from the spillway usually is discharged into a plunge pool or **stilling basin**, where the high energy of the flow is dissipated to prevent serious erosion of the streambed.

INSPECTION OF CONCRETE AND MASONRY DAMS

I. INSPECTING THE DAM: CONCRETE DAM FEATURES

Outlet Works

The **outlet works** is a system of dam components that regulates or releases water impounded by a dam. Components of an outlet works include an entrance channel, intake structure, conduit, gate or valve housing, energy dissipators, and return channel.

Penstock

A **penstock**, found only in dams with power-generating plants, is a pipeline or pressure conduit leading from a headrace or reservoir to the power-producing turbines. Because of the possibility of sudden load changes, a penstock is designed to withstand pressure surges.

OTHER STRUCTURES AND MECHANICAL EQUIPMENT

In addition to the dam itself, a concrete dam site may include various attached structures and equipment, such as powerhouses and other related buildings, diversion works, spillway and outlet works control systems, switchyards, gates and valves, trashracks, and retaining and training walls. These attached structures are often referred to as **appurtenances**.

REFERENCE CONVENTIONS

It is helpful for the inspector to understand and use a conventional reference system when making field notes and writing the inspection report. This will assist others, using the same reference system, to understand the extent and location of deficiencies observed.

When you refer to the right or left on a dam, your perspective should always be facing downstream. For example, the right abutment would be on your right-hand side when you are standing on the crest looking downstream.

Most concrete dams have some type of numbering system for the concrete blocks, although different agencies or designers use different systems. Other features in a concrete dam, such as formed drains, may also be numbered for reference. The numbering system used for the blocks, drains, and other features will probably be included on the design drawings you will be using to make field notes. Horizontal construction joints should be referenced with their elevation.

INSPECTION OF CONCRETE AND MASONRY DAMS

I. INSPECTING THE DAM: CONCRETE DAM INSPECTION TECHNIQUES

INTRODUCTION

The purpose of inspection is to identify deficiencies that potentially affect the safety of the dam. A deficiency is a condition that might affect or interfere with the safety or operational effectiveness of the dam.

This section presents some general guidelines for inspecting a concrete dam.

PREPARING FOR INSPECTION

The Preparing To Conduct A Dam Safety Inspection module discusses the things you should do prior to your arrival at the dam site. After you arrive at the site, there are additional preliminary activities you should undertake, including reviewing operation logs, talking with personnel at the dam, and ensuring that you have the proper tools and equipment to complete a thorough inspection and record your observations.

Reviewing Data

Review any available data about the dam before you begin your inspection. An important aspect of dam safety inspection is tracking conditions and potential problems to determine how and to what degree they are changing over time. Historical and design information can alert you to conditions and features that are of special concern and that should be checked and documented.

The kind and amount of data that are available will vary considerably from one dam or organization to another. Types of information that may be useful to review include the following:

- . Design criteria
- . Materials data
- . Construction records
- . Records of operation
- . Records of maintenance
- . Instrument readings
- . Dam safety inspection reports

In many cases you may find it necessary to review the records, make your inspection, then compare your observations with previous records. This will help you detect trends in deficiencies.

Talking With Personnel

Talking with personnel at the dam is an extremely valuable source of information about potential deficiencies in a dam. Operators who are at the dam on an ongoing basis have a better opportunity to observe the dam under various temperature and loading conditions than an inspector has in a single visit.

Continued . . .

INSPECTION OF CONCRETE AND MASONRY DAMS

I. INSPECTING THE DAM: CONCRETE DAM INSPECTION TECHNIQUES

Talking With Personnel (Continued)

For example, if the reservoir is low during your inspection, you will not witness a problem that occurs only when the water level is high. If the weather is hot, you may overlook a problem that tends to occur when temperatures drop. If the gates cannot be opened during your inspection because of operational restrictions, you may not realize that there are any gate problems.

Therefore, you should talk to onsite personnel about their experiences and observations to ensure that you don't overlook any problems when you conduct your inspection. It is also strongly recommended that you have someone who is familiar with the structure accompany you on the inspection.

Tools And Equipment

Be sure the right tools are available to you. Table I-1 lists tools and equipment you will find useful in conducting a safety inspection on a concrete dam. Some of these items may be available at the site.

TABLE I-1. INSPECTION TOOLS AND EQUIPMENT

Tools/Equipment	Uses
Binoculars	Viewing inaccessible areas and sighting along the crest
Camera	Recording conditions and deficiencies
Rock hammer or "bonker"	Sounding concrete or rock
Measuring tape or rule	Measuring dimensions of features or deficiencies
Probe	Measuring crack width at a depth away from the surface
Pocket knife	Scraping rock, probing crevices, etc.
Shovel	Clearing drains and exposing covered structures
Bucket and timer	Measuring seepage and other flow rates
Lights	Looking into pipes, walking galleries, etc.
Water sample kit (jar)	Checking quality (turbidity) of seepage water

INSPECTION OF CONCRETE AND MASONRY DAMS

I. INSPECTING THE DAM: CONCRETE DAM INSPECTION TECHNIQUES

GENERAL GUIDELINES

When you conduct an inspection, there are several things to keep in mind:

- . The purpose of an inspection is to gather facts. Be **creative** in the way you conduct inspections. Ask questions; probe for causes until you are satisfied.
- . Don't stop with identifying individual deficiencies. Look for continuities or relationships among deficiencies (e.g., Can you trace cracking on a face of the dam through the structure? Can you locate the source of leakage?).
- . Inspect all features of the dam. Don't take shortcuts. Take your time and allow enough time for the inspection. **Pay particular attention to areas where data indicate that change is occurring or where past deficiencies have been noted.**
- . Know your limits. **Consult an experienced and qualified engineer** or other specialist when you have a specific question or concern.
- . Take good notes; make thorough records. Experienced inspectors carry general plan and section sketches and make their inspection observations on these drawings. Use sketches, photographs, and measurements to supplement descriptive notes.
- . Use the SMPL (pronounced "Simple") rule for documenting conditions:
 - S** **Sketch** the deficiency and note its important characteristics.
 - M** **Measure** the deficiency.
 - P** **Photograph** the deficiency or describe its characteristics in writing.
 - L** **Locate** the deficiency relative to some standard reference point.

Some accepted ways of noting the location of a deficiency are by joint or block number, drain number, gallery name or number, elevation (on the downstream face) relative to sea level, or by reference (i.e., measurement) to some known feature of the dam.

INSPECTION OF CONCRETE AND MASONRY DAMS

I. INSPECTING THE DAM: CONCRETE DAM INSPECTION TECHNIQUES

DOCUMENTING AND REPORTING

During inspection, you will collect a large amount of information. The requirements for reporting your findings usually are found in your organization's policies and procedures. Regardless of specific procedures, you should make every effort to prepare the required reports **promptly** after you have completed the inspection, while impressions are still fresh in your mind.

Since your findings will add to the historical record on the project, you also should take care that you report your findings in a **clear** and **consistent** manner. Remember, another inspector may depend on your report when reviewing data prior to the next inspection.

A more detailed discussion of documenting the results of the inspection is found in the TADS module Documenting And Reporting Findings From A Dam Safety Inspection.

INSPECTING THE CREST

You may want to start your inspection on the crest of the dam, where you can get a good overall view and make general observations of most features of the dam. One approach is to walk along one side of the crest, cross over, and walk back on the opposite side while noting any deficiencies. Another is to cross back and forth from one side to the other as you walk along the crest. When inspecting the crest, be sure you cover the area thoroughly. Carefully examine:

- ✓ Condition of the crest
- ✓ Parapet walls
- ✓ Condition of movement monuments
- ✓ Bridge deck and abutments
- ✓ Condition of seals in visible joints
- ✓ Alignment of the structure
- ✓ Joints for signs of differential movement between adjacent blocks

SIGHTING TECHNIQUES FOR STRAIGHT DAMS

When checking the alignment of a straight crest, a useful sighting technique is to center your eyes along the line being viewed and move or lean from side to side in order to view the line from several angles.

Some tools to help in sighting are . . .

- . **Binoculars Or Telephoto Lens:** Using binoculars or a telephoto lens can help you see irregularities by foreshortening distances and making distortions more apparent.

Continued . . .

INSPECTION OF CONCRETE AND MASONRY DAMS

I. INSPECTING THE DAM: CONCRETE DAM INSPECTION TECHNIQUES

SIGHTING TECHNIQUES FOR STRAIGHT DAMS (Continued)

- **Reference Lines:** Using a reference line can also help you in sighting. Reference lines are existing features that serve as horizontal or vertical control points along the surface of the dam. Such features as handrails, parapet walls, crane rails, pavement stripes on the roadway, permanent monuments, and joints between blocks are useful as reference lines.

In sighting along the crest, you need to view your chosen reference line from a number of different perspectives. First sight on a direct line; then move to either side. Figure I-9 illustrates the sighting technique used along the crest of the dam.

FIGURE I-9. SIGHTING ALONG THE CREST

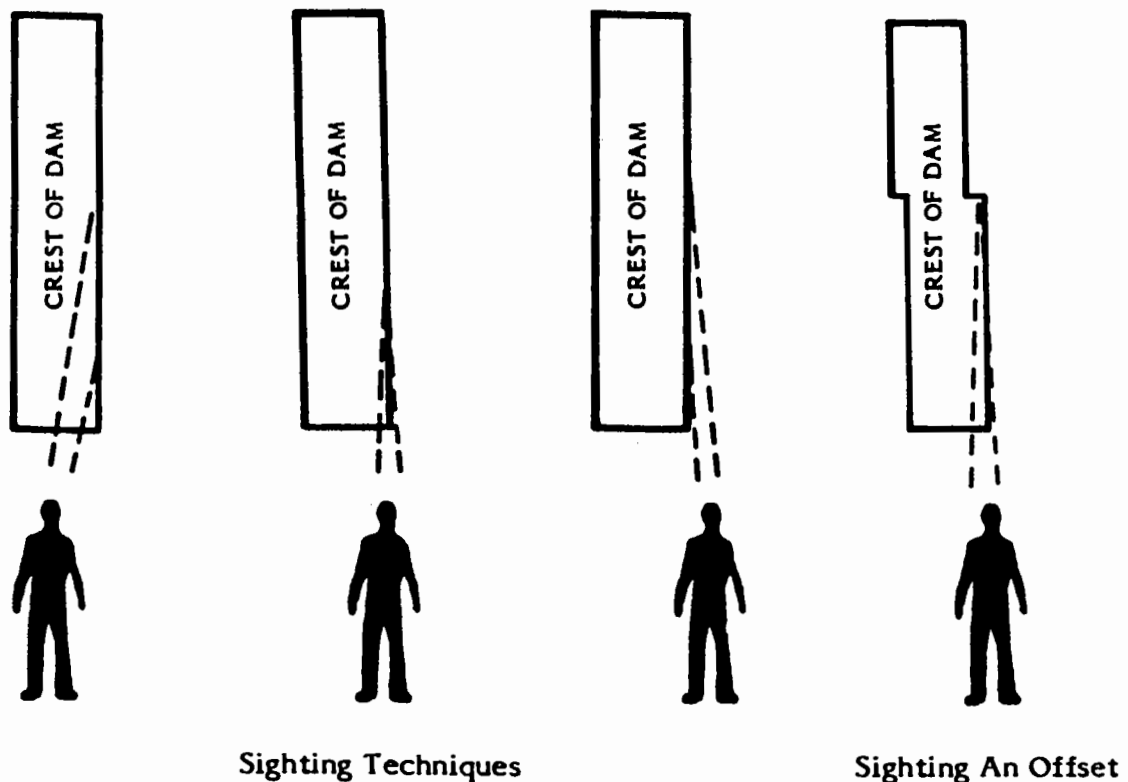

INSPECTION OF CONCRETE AND MASONRY DAMS

I. INSPECTING THE DAM: CONCRETE DAM INSPECTION TECHNIQUES

SIGHTING TECHNIQUES FOR ARCH DAMS

On an arch dam, sighting on the crest is not as effective because of the curvature of the dam. If possible, when inspecting the crest of an arch dam for misalignment . . .

- ✓ Study the crest from above, standing on either abutment.
- ✓ Note any cracks adjacent to handrails or other embedded metalwork between blocks that might indicate movement of the blocks.

INSPECTING THE UPSTREAM FACE

The upstream face should be inspected from the crest, abutments, and/or a boat. The number of positions from which you inspect the face depends on the length of the dam and its height: the larger the dam, the more positions you should use. It is desirable that the reservoir be as low as possible when you inspect the upstream face.

Although there is no particular pattern for visually scanning the upstream face, you should . . .

- ✓ Use binoculars, if necessary, to examine the face closely.
- ✓ Be sure to inspect the entire surface.
- ✓ If a particular deficiency is noted, try to study it from different perspectives. Get as close as possible--by boat, platform, or other means.

UNDERWATER INSPECTIONS

In some instances (e.g., when a problem is noted above the water line or a leak discovered inside a gallery), it may be advisable to have a dive team inspect the upstream face at a specific location below the waterline. This is a special inspection technique that is used occasionally to determine the cause or extent of a specific problem.

INSPECTING THE DOWNSTREAM FACE

If leakage is occurring or if structural distress is evident, it will most likely be found on the downstream face. It is best to inspect the downstream face with the reservoir as high as possible. This will increase your chances of seeing leakage on the downstream face of the dam and along the toe. You might, therefore, need to conduct inspections of the upstream and downstream faces at different times: upstream during low reservoir levels and downstream during high levels. Another approach is to alternate your inspections from one time to the next between high and low reservoirs.

Continued . . .

INSPECTION OF CONCRETE AND MASONRY DAMS

I. INSPECTING THE DAM: CONCRETE DAM INSPECTION TECHNIQUES

INSPECTING THE DOWNSTREAM FACE (Continued)

Inspection of the downstream face is similar to inspection of the upstream face, again requiring no particular pattern for scanning. Remember to . . .

- ✓ Carefully study the entire surface.
- ✓ Look at the surface from a number of perspectives: from the crest, abutment, toe, boat (if there is tailwater).
- ✓ Use binoculars to examine the face.
- ✓ Pay particular attention to the toe, where the structure joins the foundation material. Look carefully for . . .
 - . Seepage along the toe
 - . Alignment changes
 - . Cracks
- ✓ On a buttress dam, carefully inspect the downstream face of the slab and the buttress faces for cracking.

INSPECTING AREAS DOWNSTREAM AND UPSTREAM OF THE DAM

When inspecting areas around the dam . . .

- ✓ Walk the area downstream to the degree conditions permit. Note slides, sink holes, wet areas, lush vegetation, or other evidence of seepage along the toe or through the foundation and abutments.
- ✓ Visually scan the area upstream for signs of instability of the abutments (e.g., slides or movement).
- ✓ Focus on points where the dam face joins the abutment, looking for cracking and instability in the abutments or stress cracking of the concrete near the abutment rock.
- ✓ Look for evidence of movement of the foundation.

INSPECTION OF CONCRETE AND MASONRY DAMS

I. INSPECTING THE DAM: CONCRETE DAM INSPECTION TECHNIQUES

INSPECTING THE DAM INTERIOR

You should walk the entire gallery system. During your inspection, you should . . .

- ✓ Be sure galleries are well ventilated and adequately lighted for your safety.
- ✓ Make sure gutters and the associated drain piping system are clear and open.
- ✓ Look for changes in drainage flow from past inspections and note where drains appear blocked. Some inspectors are responsible for sounding or probing drains as part of their inspection to determine if they are opened and not blocked.
- ✓ Examine the exposed concrete for any deficiencies.
- ✓ Try to determine whether cracks are continuous through the entire structure by comparing locations on faces, on crest, and in galleries.
- ✓ Be sure that drains with pressure gages are open. The valves are closed only for short periods of time to take pressure readings.
- ✓ Check pressure gage readings for changes from historical trends.

INSPECTION OF CONCRETE AND MASONRY DAMS

I. INSPECTING THE DAM: UNIT EXERCISE

INSTRUCTIONS: Use the information presented in this unit to answer the following questions. When you have completed all of the questions, check your answers against those presented in the answer key. The answer key can be found immediately following this exercise.

1. Next to each description below, write the letter of the type of dam it describes.

TYPES OF DAMS

- a. Arch dam
- b. Buttress dam
- c. Composite dam
- d. Gravity dam
- e. Masonry dam

DESCRIPTIONS

- _____ Massive, roughly triangular in cross-section; depends on weight and shape for stability.
- _____ Comprised of upstream face and vertical walls that transfer load from face to foundation.
- _____ A thin dam that obtains stability by transmitting load into canyon walls.
- _____ Constructed of stone, brick, rock, or concrete blocks joined with mortar.
- _____ Consists of a gravity or buttress section in combination with earthfill or rockfill embankment sections.

Continued . . .

INSPECTION OF CONCRETE AND MASONRY DAMS

I. INSPECTING THE DAM: UNIT EXERCISE

2. Next to each description below, write the letter of the feature it describes.

DAM FEATURES	DESCRIPTIONS
a. Construction joint	_____ Holes drilled beneath dam to collect seepage that flows past grout curtain.
b. Contraction joint	_____
c. Formed drains	_____
d. Foundation drains	_____ Structure through or over which flood flows are discharged from a reservoir.
e. Grout curtain	_____
f. Outlet works	_____
g. Penstock	_____ Horizontal joint that occurs when new concrete is placed on a previous lift; also called lift line.
h. Spillway	_____ Pipeline or pressure conduit from reservoir to power-generating turbines.
	_____ Vertical transverse joint designed to prevent tension cracks as volumetric shrinkage occurs.
	_____ Vertical drain holes cast or formed in mass concrete during construction to intercept leakage within dam.
	_____ Structure through which normal reservoir releases are made.

Continued . . .

INSPECTION OF CONCRETE AND MASONRY DAMS

I. INSPECTING THE DAM: UNIT EXERCISE

3. Write the letter of each dam feature next to the arrow pointing to that feature in the diagram below.

- | | |
|--------------------|----------------------|
| a. Upstream face | e. Heel |
| b. Downstream face | f. Grout curtain |
| c. Gallery | g. Foundation drains |
| d. Crest | h. Toe |
| | i. Formed drain |

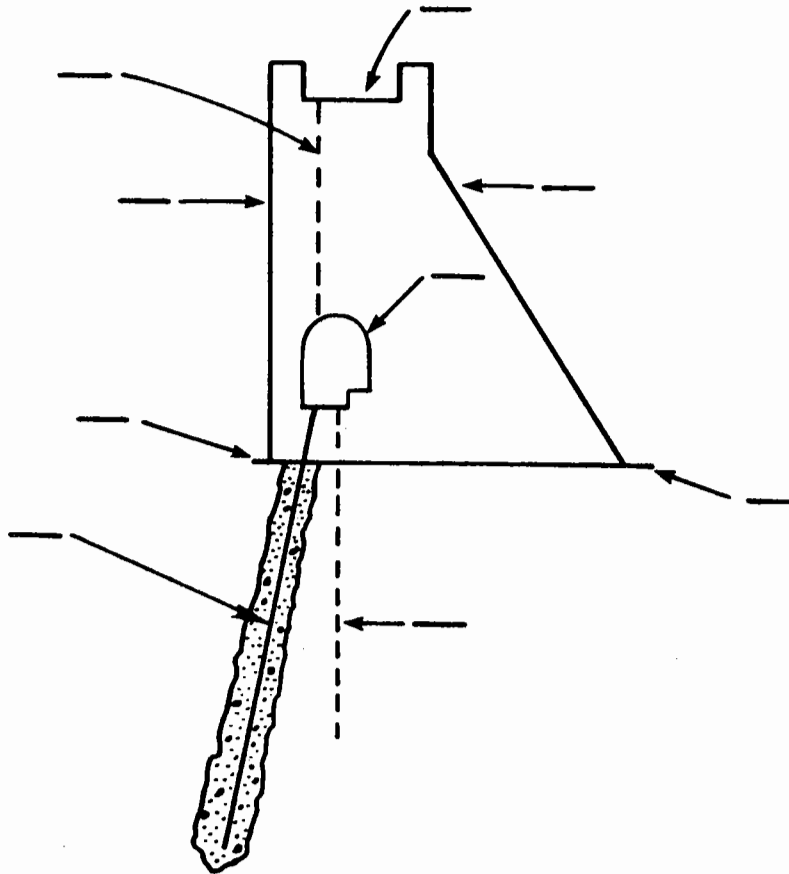

Continued . . .

INSPECTION OF CONCRETE AND MASONRY DAMS

I. INSPECTING THE DAM: UNIT EXERCISE

4. You are standing on the crest of a dam, facing away from the reservoir. If you refer to the abutment to **your** left in a report, how should you describe the abutment?

Left abutment

Right abutment

5. List at least three possible causes of concrete dam failure.

- _____
- _____
- _____

6. What is the "SMPL" rule for documentation?

INSPECTION OF CONCRETE AND MASONRY DAMS

I. INSPECTING THE DAM: UNIT EXERCISE — ANSWER KEY

INSTRUCTIONS: Compare your answers to those given below to see how well you learned the information presented in this unit.

1. Next to each description below, write the letter of the type of dam it describes.

TYPES OF DAMS

- a. Arch dam
- b. Buttress dam
- c. Composite dam
- d. Gravity dam
- e. Masonry dam

DESCRIPTIONS

- d Massive, roughly triangular in cross-section; depends on weight and shape for stability.
- b Comprised of upstream face and vertical walls that transfer load from face to foundation.
- a A thin dam that obtains stability by transmitting load into canyon walls.
- e Constructed of stone, brick, rock, or concrete blocks joined with mortar.
- c Consists of a gravity buttress section in combination with earthfill or rockfill embankment sections.

Continued . . .

INSPECTION OF CONCRETE AND MASONRY DAMS

I. INSPECTING THE DAM: UNIT EXERCISE — ANSWER KEY

2. Next to each description below, write the letter of the dam feature it describes.

DAM FEATURES		DESCRIPTIONS
a.	Construction joint	<u>d</u> Holes drilled beneath dam to collect seepage that flows past grout curtain.
b.	Contraction joint	
c.	Formed drains	
d.	Foundation drains	<u>h</u> Structure through or over which flood flows are discharged from a reservoir.
e.	Grout curtain	
f.	Outlet works	
g.	Penstock	<u>a</u> Horizontal joint that occurs when new concrete is placed on a previous lift; also called lift line.
h.	Spillway	<u>g</u> Pipeline or pressure conduit from reservoir to power-generating turbines.
		<u>b</u> Vertical transverse joint designed to prevent tension cracks as volumetric shrinkage occurs.
		<u>c</u> Vertical drain holes cast or formed in mass concrete during construction to intercept leakage within dam.
		<u>f</u> Structure through which normal reservoir releases are made.

Continued . . .

INSPECTION OF CONCRETE AND MASONRY DAMS

I. INSPECTING THE DAM: UNIT EXERCISE – ANSWER KEY

3. Write the letter of each dam feature next to the arrow pointing to that feature in the diagram below.

- | | | | |
|----|-----------------|----|-------------------|
| a. | Upstream face | e. | Heel |
| b. | Downstream face | f. | Grout curtain |
| c. | Gallery | g. | Foundation drains |
| d. | Crest | h. | Toe |
| | | i. | Formed drain |

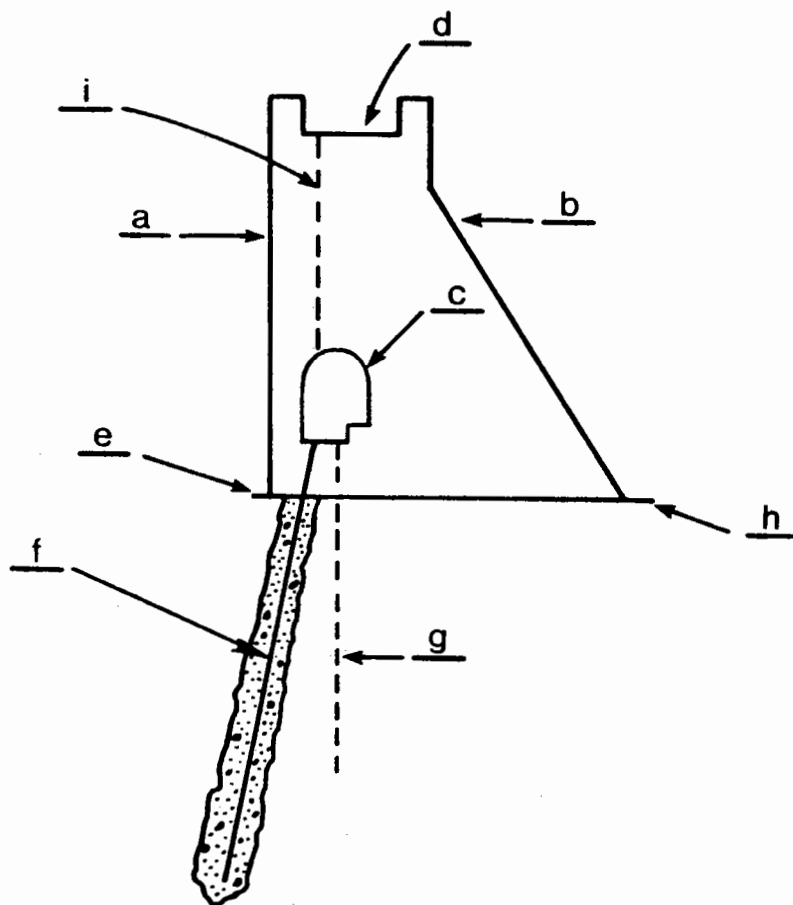

Continued . . .

INSPECTION OF CONCRETE AND MASONRY DAMS

I. INSPECTING THE DAM: UNIT EXERCISE — ANSWER KEY

4. You are standing on the crest of a dam, facing away from the reservoir. If you refer to the abutment to **your** left in a report, how should you describe the abutment?

Left abutment **Right abutment**

5. List at least three possible causes of concrete dam failure.

Any of the following:

- . **Overturning or sliding**
- . **Overtopping**
- . **Abutment or foundation failure**
- . **Structural failure of concrete**

6. What is the "SMPL" rule for documentation?

Sketch, Measure, Photograph, Locate

INSPECTION OF CONCRETE AND MASONRY DAMS

I. INSPECTING THE DAM: SUMMARY

This section provided basic information about concrete dams and some general guidelines for inspecting concrete dams.

A good inspector is **systematic** in carrying out an inspection. Often you are dealing with very large structures in which the steepness of the faces does not allow close-up examination (unless elaborate arrangements, such as high ropes and chairs, are made). Therefore, you must **take your time; be thorough** in studying each face from a number of positions.

Finally, it cannot be overemphasized--**SMPL**: Sketch, Measure, Photograph, and Locate. The quality of your notes and sketches, and the accuracy with which you locate any deficiencies you observe, will affect the quality of future inspections.

In the next unit, you will learn how to detect specific deficiencies in concrete dams.

UNIT III
INSPECTING FOR DEFICIENCIES

INSPECTION OF CONCRETE AND MASONRY DAMS

II. INSPECTING FOR DEFICIENCIES: OVERVIEW

INTRODUCTION

The purpose of inspection is to identify, monitor, and record potential dam safety deficiencies that exist in the dam. This unit presents information on . . .

- . The kinds of deficiencies you will be expected to identify.
- . The impact those deficiencies have on the safety of a concrete or masonry dam.
- . The actions you should take if you find deficiencies.

Concrete and masonry dams are subject to several different types of deficiencies, each of which will be discussed in detail in this unit:

- . Cracking
- . Concrete deterioration
- . Masonry deterioration
- . Surface defects
- . Displacement
 - Misalignment
 - Differential movement
- . Leakage and seepage
- . Maintenance concerns
 - Drainage
 - Vegetation
 - Debris
 - Joint condition
 - Previous repairs
 - Environmental conditions

UNIT OBJECTIVES

After completing this unit, you will be able to . . .

- . Identify and explain the characteristics and potential consequences of cracking, concrete deterioration, surface defects, displacement, leakage and seepage, and inadequate maintenance.
- . Explain what actions should be taken to protect the dam.

INSPECTION OF CONCRETE AND MASONRY DAMS

II. INSPECTING FOR DEFICIENCIES: CRACKING

WHAT IS CRACKING?

All concrete is subject to cracking. A crack is a separation into one or more parts, with or without space between the parts. In most cases, cracking is the first visible sign of concrete distress.

Cracking in a concrete dam occurs when tensile stresses develop that exceed the tensile strength of the concrete. These stresses may occur because of **imposed loads** on the structure or because of **volumetric changes** in the concrete. Volumetric change in mass concrete can be caused by changes in temperature or by a chemical reaction within the concrete.

You will see many cracks in the course of your inspections, and not all cracks are serious. However, as we will discuss later in this unit, cracking should be monitored because cracks can provide openings in the concrete that allow other types of deficiencies to develop.

CHARACTERISTICS OF CRACKS

Cracks in a concrete dam can be described in terms of several characteristics: length, width, direction, depth, location, and trend (change).

Length

Length is a self-evident concept. The length of a crack is established by measurement.

Width

The width of a crack is the amount of separation between the two concrete parts. One common mistake made by some inspectors is that they measure the width of a crack at the surface, where deterioration of the concrete may exaggerate the true dimensions of the crack. Although surface deterioration should be noted, it should not be included in an estimate of crack width. If possible, you should measure or estimate crack width at a depth below the surface deterioration by inserting a probe such as a knife blade or wire. Figure II-1 illustrates how to determine the width of a crack.

Continued . . .

INSPECTION OF CONCRETE AND MASONRY DAMS

II. INSPECTING FOR DEFICIENCIES: CRACKING

Width (Continued)

FIGURE II-1. DETERMINING CRACK WIDTH
(Sectional View)

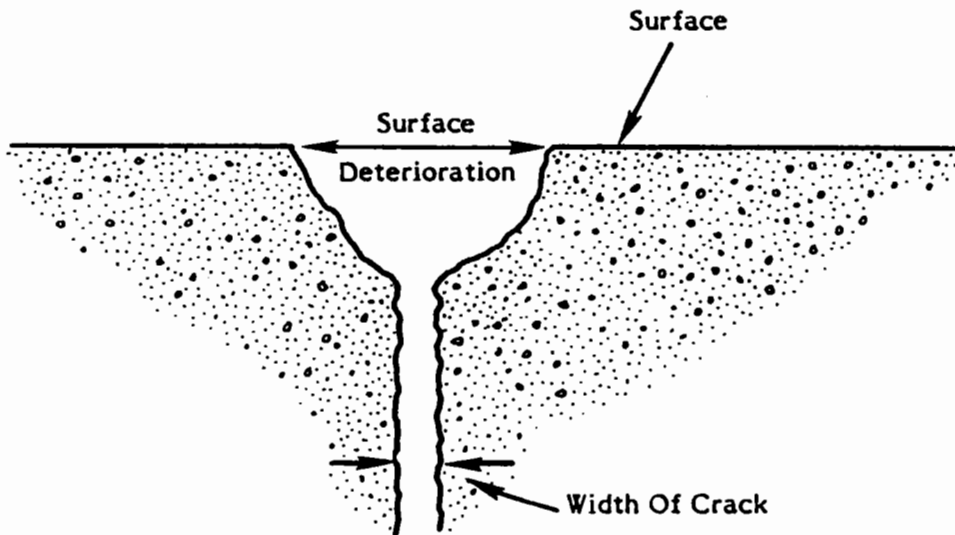

Direction

The direction, or **orientation**, of a crack can be described using one or more of the following terms, which are illustrated in Figure II-2:

- . **Longitudinal:** A longitudinal crack runs roughly parallel to the crest of the dam.
- . **Transverse:** A transverse crack runs roughly perpendicular to the crest of the dam.
- . **Horizontal:** A horizontal crack is one that lies at a single elevation.
- . **Vertical:** A vertical crack runs up and down.
- . **Diagonal:** A diagonal crack shows some inclination between horizontal and vertical.

Cracking also can occur in random patterns (e.g., alligator pattern) over the concrete surface.

Continued . . .

INSPECTION OF CONCRETE AND MASONRY DAMS

II. INSPECTING FOR DEFICIENCIES: CRACKING

Direction (Continued)

FIGURE II-2. ORIENTATION OF CRACKING

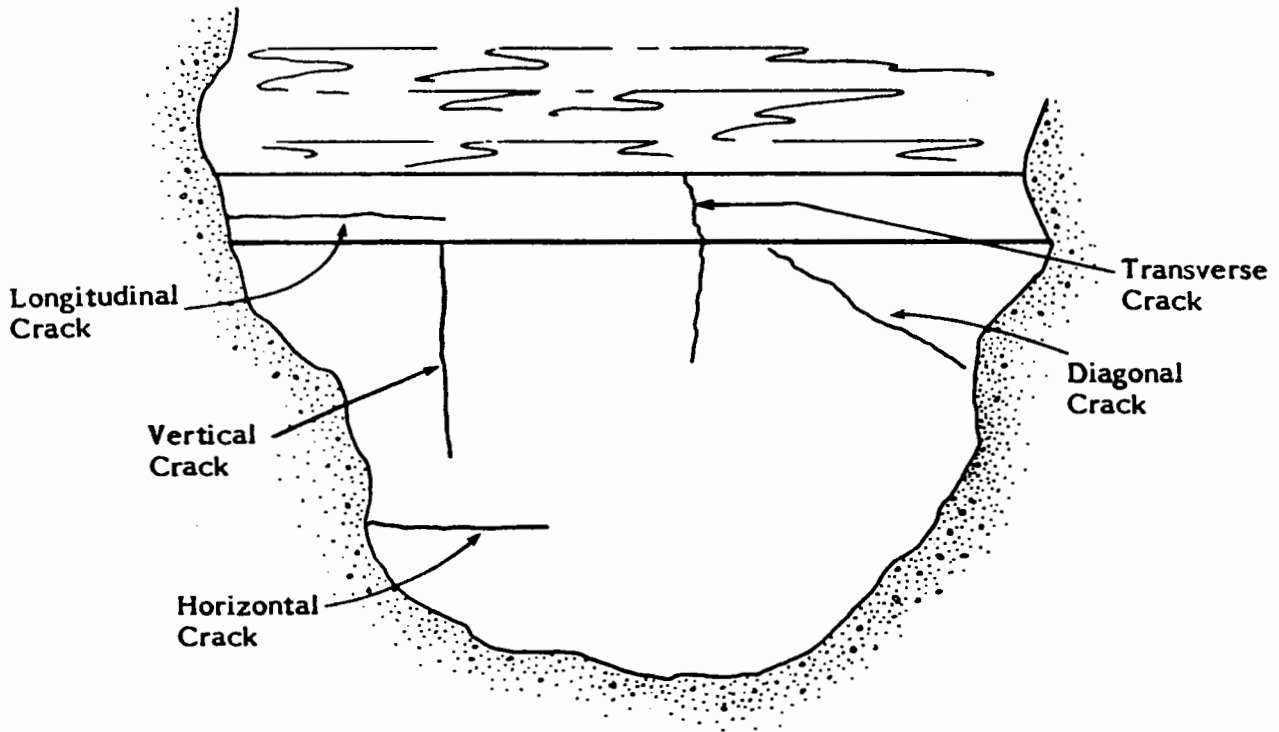

Depth

The full depth of a crack may be difficult to determine unless the crack extends to another face or interior surface of the dam, such as a gallery or chamber wall.

Trend

Trend is extremely important in monitoring cracking. The trend of a crack is its history of change. Studying prior reports before you begin an inspection will enable you to focus on how cracks have changed--that is, whether they have become longer, wider, or deeper, changed direction, or remained unchanged. Documenting any changes you observe will enable future inspectors to do the same thing.

Measuring devices, or reference points, are sometimes permanently placed across a crack to monitor the change in width over time. This type of instrumentation is covered in the Instrumentation For Embankment And Concrete Dams module.

INSPECTION OF CONCRETE AND MASONRY DAMS

II. INSPECTING FOR DEFICIENCIES: CRACKING

Location

Identifying the location of a given crack is vital to monitoring its trend in future inspections. In Unit I we discussed some of the reference conventions:

- . Left and right facing downstream
- . Block and joint numbers
- . Drain numbers

Other reference points are also useful:

- . Stations (measured along the axis of the dam)
- . Lift lines
- . Elevation (on the downstream face of the dam)
- . Gallery name or number
- . Measurements from any identifiable feature of the dam (e.g., structures, handrails, doorways)

TYPES OF CRACKS

Cracking in concrete dams generally falls into the following four categories:

- . Structural cracks
- . Cracks along joints
- . Shrinkage cracks
- . Thermal cracking
- . Pattern cracking
- . D-Cracking
- . Other Shallow Cracking

Structural Cracks

A potentially serious type of crack is the **structural crack**--a crack that calls into question the structural integrity of an element. Structural cracks are caused by the overstressing of portions of the dam because of extreme loading conditions, inadequate design, poor construction techniques, or faulty materials.

Often, structural cracks can be related to some feature of the dam where stress concentrations occur--for example . . .

- . The corner of an opening
- . Areas of large temperature gradient
- . Discontinuities in the foundation caused by material or alignment changes or by differential movement in foundation or abutments

Continued . . .

INSPECTION OF CONCRETE AND MASONRY DAMS

II. INSPECTING FOR DEFICIENCIES: CRACKING

Structural Cracks (Continued)

Structural cracks are often irregular; that is, they run at an angle to the major axes of the dam and they may change direction abruptly. These cracks are usually wide and may be associated with noticeable displacement of the concrete adjacent to the crack. The opening may tend to increase as a result of continuous loading and creep of the concrete. Figure II-3 shows an irregular structural crack with vertical displacement.

**FIGURE II-3. STRUCTURAL CRACK WITH VERTICAL DISPLACEMENT
(Elevation View)**

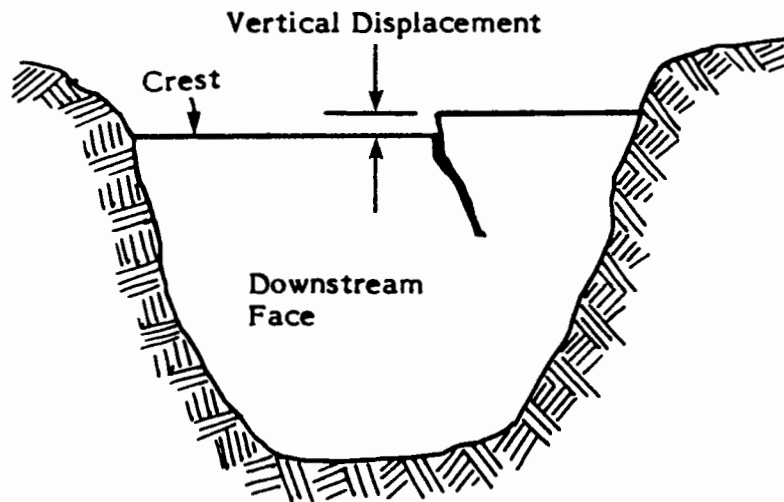

Cracks Along Joints

Cracking may occur along joints because of structural movement, volumetric changes, or chemical reactions. Some of these cracks are intentional and occur by design. Other cracks along joints are not intentional and may pose a threat to the integrity of the dam. Document any new or worsening cracks along joints, unless you are certain that these cracks are there by design.

INSPECTION OF CONCRETE AND MASONRY DAMS

II. INSPECTING FOR DEFICIENCIES: CRACKING

Shrinkage Cracks

When concrete is subjected to cycles of wetting and drying, it expands and contracts. Volume changes occur during this process and develop tensile stresses within the concrete, causing cracking. Shrinkage cracks due to drying are generally fine and show no evidence of movement. They are usually shallow, but they can be several feet long.

Shrinkage cracks often occur soon after construction, as the cement paste cures and shrinks. These cracks usually occur shortly after construction and usually do not penetrate deeply enough to be a threat.

Thermal Cracking

When concrete is placed in large sections, high tensile stresses can result from the heat generated by the hydration of cement, followed by differential cooling. When tensile stresses exceed the tensile strength of the concrete, the concrete will crack. Cracking due to thermal stresses is usually orthogonal (rectangular) or blocky. Thermally induced cracks are generally much deeper than shrinkage cracks.

Cracks also can be caused by temperature variations not associated with construction. During cold weather, upper portions of the dam may become colder than the lower portions that are in contact with the reservoir water. This temperature difference can cause cracks to form, extending from the crest down each face of the dam.

Pattern Cracking

Pattern cracking is indicated by fine openings on concrete surfaces in the form of a pattern. Pattern cracking results from a decrease in volume of the material near the surface, or increase in volume of the material below the surface, or both. Figure II-4 illustrates pattern cracking.

FIGURE II-4. PATTERN CRACKING

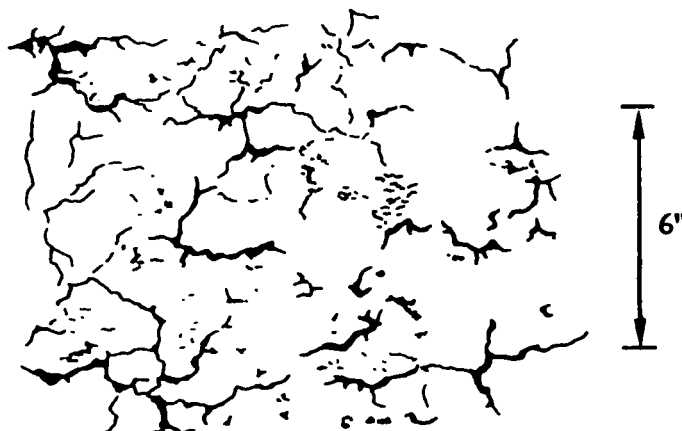

Continued . . .

INSPECTION OF CONCRETE AND MASONRY DAMS

II. INSPECTING FOR DEFICIENCIES: CRACKING

Pattern Cracking (Continued)

Pattern cracks usually indicate a problem, such as freeze-thaw action or some type of undesirable chemical reaction occurring in the concrete. Chemical reactions will be discussed in greater detail under concrete deterioration.

Freeze-thaw action occurs when water enters the pores, cracks, or joints in the concrete. When the water freezes, it expands and causes the concrete to crack. Water then can enter the new cracks and, when it freezes, cause the cracks to widen, or spall at the surface.

D-Cracking

Sometimes **D-cracking** along joints is an early sign that freeze-thaw action has occurred. (D-cracking is the progressive formation of a series of fine cracks at close intervals, often in random D-shaped patterns along a joint.) Figure II-5 illustrates D-cracking. As the cycle continues, the cracks extend farther away from the joint and become more severe. This process may lead to further disintegration of the concrete.

FIGURE II-5. D-CRACKING

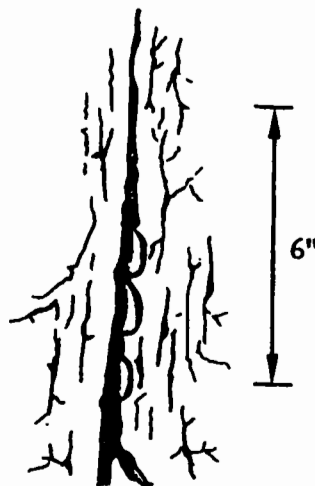

Virtually all mass concrete placed in recent years has included entrained air to reduce freeze-thaw deterioration. Dams built before about 1970, when air entrainment technology was developed, however, are prone to this deficiency, so you should be particularly alert to signs of freeze-thaw action in older dams.

INSPECTION OF CONCRETE AND MASONRY DAMS

II. INSPECTING FOR DEFICIENCIES: CRACKING

Other Shallow Cracking

Other types of shallow cracking you may notice in concrete surfaces are checking and hairline cracking. **Checking** refers to the development of shallow cracks at closely spaced but irregular intervals on the surface of mortar or concrete. **Hairline cracking** refers to small cracks of random pattern in an exposed concrete surface.

CRACK SURVEYS

A crack survey is an examination of a concrete structure for the purpose of locating, recording, and identifying cracks and of noting the relationship of the cracks with other destructive phenomena. Since cracking is often the first noticeable symptom of concrete distress, a survey is a significant part of evaluating the future serviceability of the structure. Some cracks may occur early and not progress, while others may occur later and increase in extent. Some may occur after an unusual event. A design drawing or inspection drawing is often used to record the location and extent of cracks in this type of survey.

A crack survey should identify . . .

- . Characteristics of the cracks (length, width, direction, depth, and location)
- . Descriptions of types
- . Descriptions of other conditions or deficiencies that may be associated with cracking

Whenever feasible, external cracks should be correlated with internal cracks. Where repairs have been made to the concrete, crack surveys are difficult to perform and may be unreliable because cracks beneath the repairs may indicate deficiencies at greater depths. It is significant, however, to note whether new cracks have developed in the repair concrete. Such cracks may indicate continued structural problems.

CRACKING: INSPECTION ACTIONS

There is no single rule for how to respond to cracking. In some cases you will merely make notes in the records so that the cracks can be monitored; in serious cases you will need to recommend review by an experienced, qualified engineer or perhaps call him or her in immediately. How do you know what is important and requires action?

Generally speaking, most cracks will fall into the "to-be-monitored" category--cracks that have been monitored in the past and should be measured and documented. A good ongoing record is necessary in order to identify significant change or trend. New, severe, or extensive cracking and sudden changes warrant some action on your part. The following are a few inspection guidelines.

Continued . . .

INSPECTION OF CONCRETE AND MASONRY DAMS

II. INSPECTING FOR DEFICIENCIES: CRACKING

CRACKING: INSPECTION ACTIONS (Continued)

- ✓ For cracks that have been monitored and documented before, take measurements and document any changes. Based on the trend noted for a particular crack, you may wish to decrease the interval between measurements or install appropriate instrumentation.
- ✓ If you observe prominent cracks or cracking over large areas, measure and document them. In these cases, too, more frequent measurements or installation of instrumentation may be advisable.
- ✓ If you observe extensive new cracking, consider initiating a crack survey to thoroughly document all cracks in the structure and their characteristics.
- ✓ If you observe a major new crack, or one whose characteristics have changed drastically from the previous inspection, **contact an experienced and qualified engineer for assessment of the situation as quickly as possible.**
- ✓ If you observe cracks indicating movement that might be detrimental to the structure or to equipment operation (e.g., misalignment of gates that impedes gate operation and water release), **contact an experienced and qualified engineer for an immediate assessment.**
- ✓ If you find that an excessive amount of water which cannot be handled by the drainage system is flowing through a crack, recommend repairs. **Check with a concrete specialist to identify appropriate repair procedures.**

 **INSPECTION TIP:** If you are at all unsure about the severity of cracking, bring it to the attention of an experienced and qualified engineer so the situation can be evaluated.

INSPECTION OF CONCRETE AND MASONRY DAMS

II. INSPECTING FOR DEFICIENCIES: CONCRETE DETERIORATION

WHAT IS CONCRETE DETERIORATION?

Deterioration is any adverse change on the surface or in the body of the concrete that is caused by separation of components of the concrete.

TYPES OF DETERIORATION

There are numerous observable conditions that can indicate concrete deterioration. Cracks, which we have discussed at some length, can be considered a specific type of deterioration, and they are often associated with other types of deterioration. The following are the most common types of concrete deterioration that you are likely to encounter.

Disintegration

Disintegration is deterioration of concrete into small particles, or crumbling, due to any cause.

Spalling

Spalling is the loss of chunks of concrete from a surface, usually because of compression, impact, or abrasion. Spalling often occurs at the edges of concrete (e.g., along cracks, joints, and corners or next to embedded objects). Figure II-1, presented earlier in this unit, showed a spall along a crack. Spalling may have various causes:

- . A blow to the concrete
- . Action of weather
- . Internal pressure (e.g., from a corroded rebar near the surface)
- . Expansion within the concrete mass

Although spalls themselves are confined to the surface of the concrete and thus may not be a serious problem, spalling can lead to secondary problems. For example, spalling may expose reinforcement, create a seepage path around an embedded waterstop at a joint, create an offset along the flow surface, or develop into a point of structural weakness.

Efflorescence

Efflorescence is a deposit of salts from within the concrete that forms on the surface. Efflorescence is caused by water leaking through joints and cracks, leaching calcium hydroxide or carbonate from the cement, and carrying it to the exposed surface. As the water evaporates, a hard, white calcium deposit forms on the surface.

Continued . . .

INSPECTION OF CONCRETE AND MASONRY DAMS

II. INSPECTING FOR DEFICIENCIES: CONCRETE DETERIORATION

Efflorescence (Continued)

As calcium is leached from the concrete around the joint, the opening may widen. This in turn leads to increased leakage and faster deterioration. It should be noted, however, that leaching also can be a self-healing process. In some cases the calcium may be deposited in such a way around the joint that it seals the opening against additional leakage.

Drummy Concrete

Drummy concrete is concrete that has a void, separation, or other weakness within the concrete--usually a thin surface layer separated from the mass. You can check for drummy concrete by striking a hammer or "bonker" against the surface and listening for a hollow sound. Figure II-6 illustrates drummy concrete.

FIGURE II-6. DRUMMY CONCRETE
(Elevation View)

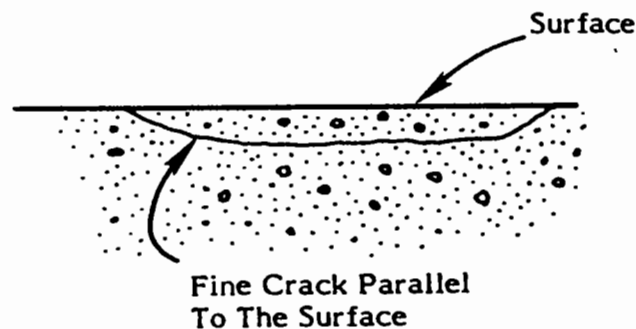
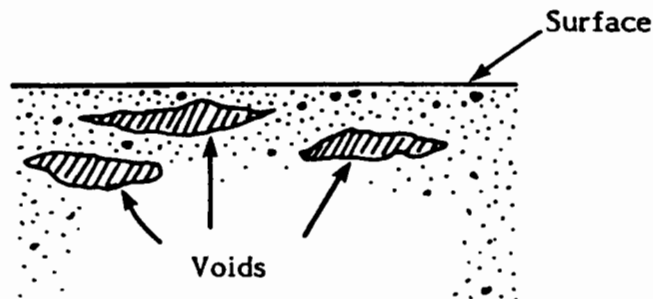

INSPECTION OF CONCRETE AND MASONRY DAMS

II. INSPECTING FOR DEFICIENCIES: CONCRETE DETERIORATION

Popouts

A **popout** is a small portion of the concrete surface that breaks away, due to internal pressure, leaving a shallow, conical depression. Figure II-7 illustrates popouts.

**FIGURE II-7. POPOUTS
(Elevation View)**

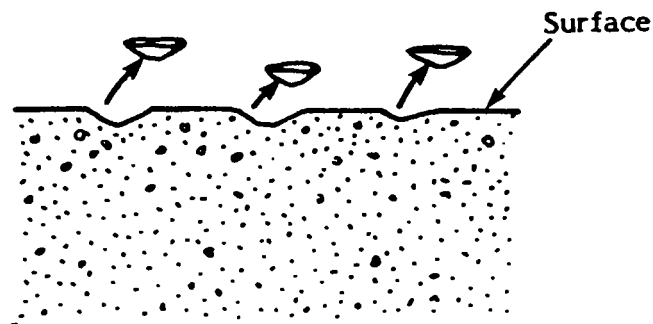

Pitting

Pitting is the development of relatively small cavities in the concrete surface. Pitting is caused by localized disintegration. Figure II-8 illustrates pitting.

**FIGURE II-8. PITTING
(Elevation View)**

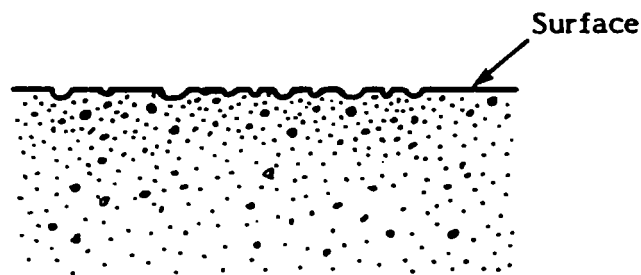

INSPECTION OF CONCRETE AND MASONRY DAMS

II. INSPECTING FOR DEFICIENCIES: CONCRETE DETERIORATION

Scaling

Scaling is the flaking or peeling away of the surface of the concrete or mortar. Figure II-9 illustrates scaling.

**FIGURE II-9. SCALING
(Elevation View)**

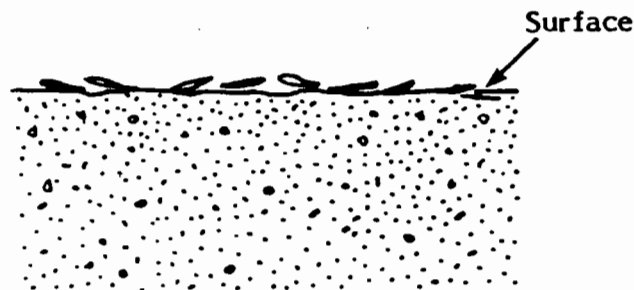

CAUSES OF CONCRETE DETERIORATION

In most cases **cracking** is both an initial cause and an effect of concrete deterioration. That is, by exposing internal surfaces of the concrete to weathering, seepage, chemicals, or other elements, cracks lead to further deterioration. At the same time, cracking is often an indication that concrete deterioration is occurring.

INSPECTION TIP: Whenever you observe cracking, you should be alert to the possibility of other types of concrete deterioration.

We have already discussed drying shrinkage, thermal stress, and freeze-thaw action as causes of concrete deterioration. Other common causes of concrete deterioration are the following:

- . Faulty concrete mixes
- . Chemical attack
- . Metal corrosion
- . Erosion
- . Cavitation

Faulty Concrete Mixes

Ingredients used to make mass concrete must be carefully proportioned to produce concrete of adequate strength and durability. When concrete mixes contain improperly graded aggregates or improper cement or water content, the concrete may lack strength and be subject to disintegration.

INSPECTION OF CONCRETE AND MASONRY DAMS

II. INSPECTING FOR DEFICIENCIES: CONCRETE DETERIORATION

Chemical Attack

There are three common types of chemically induced deterioration in concrete: sulfate attack, acid attack, and alkali-aggregate reaction.

Sulfate Attack: Sulfate attack is a chemical and/or physical reaction between sulfates in soil or ground water and concrete. The reaction causes expansion, or **growth**, in the concrete, which leads to disintegration. Concrete attacked by sulfate is usually light in color and falls apart easily when struck with a hammer. Other typical symptoms of sulfate attack include . . .

- . Cracking
- . Spalling
- . Scaling
- . Stains

Mix designs before about 1930 did not consider sulfate attack. Therefore, dams built prior to the 1930's may be particularly prone to sulfate attack.

Acid Attack: Acid attack is usually the result of bacterial action on the calcium hydroxide found in hydrated Portland cement, limestone, or dolomitic aggregates. In most cases, the reaction results in leaching away of water-soluble compounds. Symptoms of acid attack may include . . .

- . Efflorescence
- . Cracking
- . Spalling
- . Color change

Acidic water created by this reaction can also hasten corrosion of embedded steel reinforcement. As the steel corrodes, internal pressures develop, which may crack or spall adjacent concrete.

Alkali-Aggregate Reaction: An alkali-aggregate reaction is an undesirable chemical reaction between cement and aggregate that causes abnormal expansion and cracking. There are two main kinds of alkali-aggregate reaction: alkali-carbonate reaction and alkali-silica reaction. Early indicators include . . .

- . Pattern cracking, usually concentrated in areas that are exposed to moisture in a wet-dry cycle (e.g., piers, parapets, and the top of the dam)
- . Efflorescence
- . Incrustation
- . White rings around aggregate particles
- . A gel-like substance at pores, cracks, or openings in the concrete (only for alkali-silica reactions)

Continued . . .

INSPECTION OF CONCRETE AND MASONRY DAMS

II. INSPECTING FOR DEFICIENCIES: CONCRETE DETERIORATION

Chemical Attack (Continued)

Extreme alkali-aggregate reactions are characterized by closing of expansion joints, hence the term **growth of concrete** is sometimes used. Continued reaction can result in . . .

- . Debonding of blocks at lift lines
- . Binding of gates, valves, and metalwork
- . Severe cracking
- . Loss of strength and ultimate failure of the structure by sliding or overturning

Older dams that were built before the advent (about 1940) of low-alkali cements, or where designers failed to recognize reactive aggregate, are prone to alkali-aggregate reaction.

Metal Corrosion

Embedded reinforcing steel normally is protected by the concrete. When the concrete deteriorates, however, water can reach the steel and cause it to corrode. The oxide produced during corrosion results in an increase in volume, which causes the overlying concrete to crack and spall. The most well-known form of corrosion is rust. Indicators of rust corrosion in reinforcing steel include . . .

- . Cracks running in straight, parallel lines at uniform intervals corresponding to the reinforcement spacing
- . Rust stains on the surface
- . Spalling
- . Exposed reinforcement

Figure II-10 shows concrete deterioration due to metal corrosion.

FIGURE II-10. CONCRETE DETERIORATION DUE TO METAL CORROSION

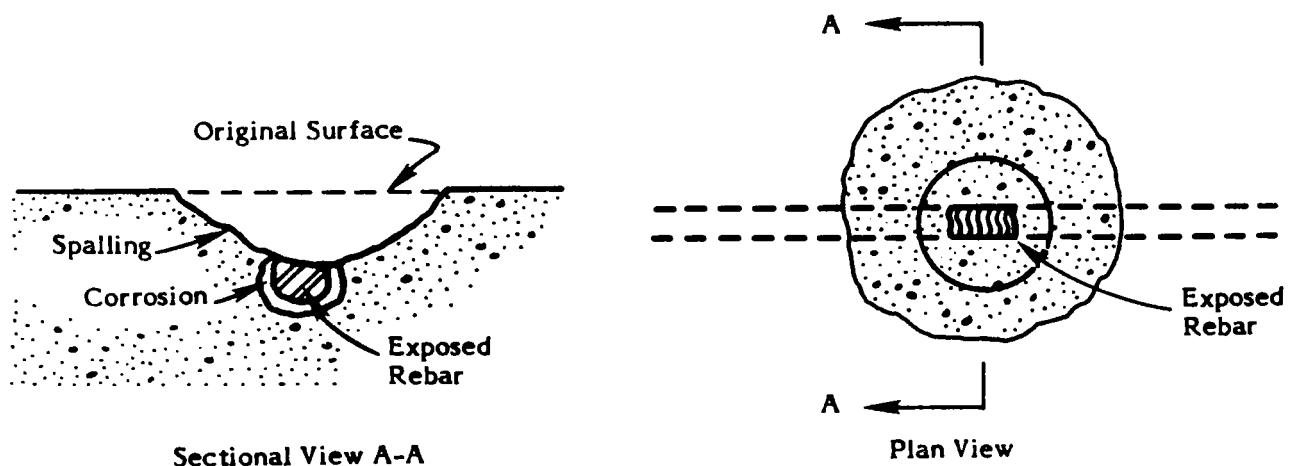

Continued . . .

INSPECTION OF CONCRETE AND MASONRY DAMS

II. INSPECTING FOR DEFICIENCIES: CONCRETE DETERIORATION

Metal Corrosion (Continued)

Other types of corrosion to steel reinforcement bars include . . .

- **Galvanic corrosion**, which occurs at metal-to-metal connections and contact points and may appear as corrosion in one of the metals but not the other.
- **Pitting corrosion**, which appears as small cavities or craters on the metal and may be indicated by changes in surface texture of the metal.
- **Stress corrosion**, which is a result of the combined action of environmental corrosion and the application of stress to the metal. This type of corrosion cannot be detected by observation alone and can result in rapid, brittle failure of the metal without warning.

Erosion

Portions of a concrete dam that are subject to fast-moving water containing abrasive material, such as spillways and outlet works, may be subject to erosion caused by abrasion. Abrasion-erosion damage may result from the abrasive effects of gravel, rocks, and other debris being carried over the concrete surface.

Cavitation

Cavitation is the formation and subsequent collapse of vapor bubbles in the water stream. When water flows at high velocity (e.g., above 40 feet per second) into areas of low pressure due to sudden directional change, vapor bubbles are produced. When the bubbles reach a higher pressure zone, they collapse suddenly. The collapse creates a shock wave that places stress on the concrete surface, rather like the blow of a hammer. Repeated collapse of vapor bubbles on or near the surface of the concrete may cause pitting.

Cavitation can cause damage to high-quality concrete in a comparatively short time. In modern dams, air slots in the waterways have been shown to reduce cavitation damage.

SURFACE MAPPING

Surface mapping involves documenting concrete defects in a systematic manner. All types of deterioration, as discussed in this section of the module, should be included. Surface mapping can be accomplished using detailed drawings, photographs, or videotape. When photographs are used, a ruler or familiar object should be included to indicate scale. A grid is sometimes used to overlay a section of a drawing so the location of cracks and other defects can be shown easily. Figure II-11 shows an example of surface mapping of concrete deterioration.

Continued . . .

INSPECTION OF CONCRETE AND MASONRY DAMS

II. INSPECTING FOR DEFICIENCIES: CONCRETE DETERIORATION

SURFACE MAPPING (Continued)

FIGURE II-11. SURFACE MAPPING

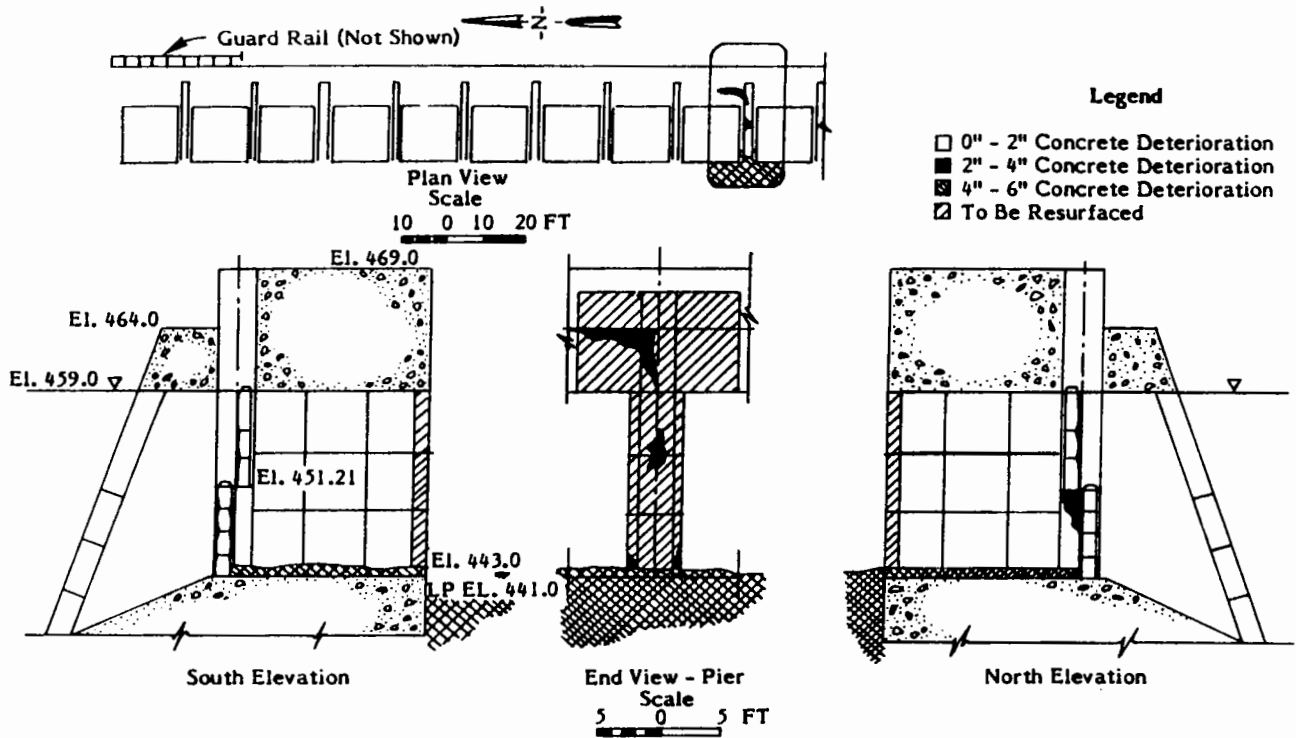

INSPECTION OF CONCRETE AND MASONRY DAMS

II. INSPECTING FOR DEFICIENCIES: CONCRETE DETERIORATION

CONCRETE DETERIORATION: INSPECTION ACTIONS

Common sense and your organization's procedures must guide you in responding to concrete deterioration. If you observe cracking or other deterioration of concrete, you should . . .

- ✓ Use the SMPL rule to document the deterioration--sketch, measure, photograph, and locate.
- ✓ If surface maps exist, or if deterioration has been documented before, compare your observations with recorded data and document your findings.
- ✓ Be alert to other types of deterioration in the concrete that may be related to an overall problem.
- ✓ Use a hammer or "bonker" to sound the concrete surface for drummy concrete.

 **INSPECTION TIP:** Immediately notify an experienced, qualified engineer of any deterioration that is extensive, has changed significantly since the previous inspection, or appears to affect the integrity of the structure.

INSPECTION OF CONCRETE AND MASONRY DAMS

II. INSPECTING FOR DEFICIENCIES: MASONRY DETERIORATION

TYPES OF DETERIORATION

Masonry dams, composed of stone, brick, rock, or concrete joined with mortar, are subject to three related types of deterioration:

- . Deterioration of the mortar
- . Loosening and movement of the blocks
- . Dislodging of blocks during overtopping

Deterioration of the mortar is a primary concern in masonry dams. As mortar ages it may crumble, leading to voids in the mortar. Unsound mortar in turn can lead to leakage and to loosening and movement of the blocks. If movement is so great that blocks are dislodged when the dam is overtopped, failure of the dam may result.

MASONRY DETERIORATION: INSPECTION ACTIONS

When inspecting a masonry dam, you should . . .

- ✓ Check the mortar to see if it is sound. Use a geologist's tool or an ice pick to pick at the mortar. If the mortar crumbles or can be picked out, there may be a problem.
- ✓ Inspect the blocks as you would on a concrete dam, looking for leakage along joints, deterioration, and cracking.
- ✓ Look for signs of loose blocks or blocks that have moved.
- ✓ Notify an experienced, qualified engineer if you observe extensive areas of unsound mortar, loose or missing blocks, or extensive leakage around blocks.

INSPECTION OF CONCRETE AND MASONRY DAMS

II. INSPECTING FOR DEFICIENCIES: SURFACE DEFECTS

WHAT ARE SURFACE DEFECTS?

Surface defects are other concrete deficiencies that are not progressive in nature; that is, they do not necessarily become more extensive with time. They may include . . .

- Shallow deficiencies in the surface of the concrete.
- Textural defects resulting from improper construction techniques.
- Localized damage to the concrete surface.

TYPES OF SURFACE DEFECTS

Among the most common types of surface defects are honeycomb, stratification, evidence of form slippage, stains, and impact damage.

Honeycomb (Rockpocket)

Honeycomb is a void that is left in the concrete when the mortar fails to fill the spaces between the coarse aggregate particles effectively. Honeycomb is caused by poor construction practices, such as inadequate concrete mixing, segregation due to improper placement practices, or inadequate vibration after placement in the forms. Figure II-12 shows an example of honeycomb.

FIGURE II-12. HONEYCOMB

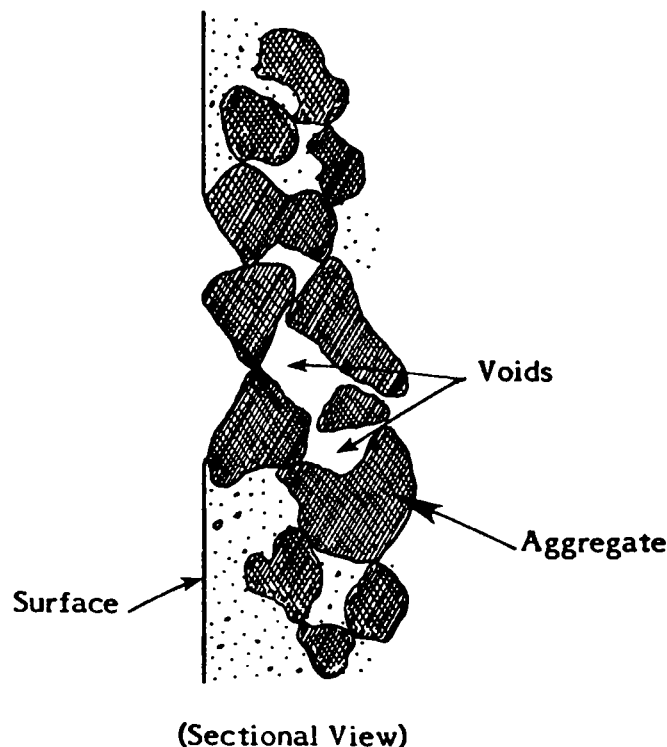

INSPECTION OF CONCRETE AND MASONRY DAMS

II. INSPECTING FOR DEFICIENCIES: SURFACE DEFECTS

Stratification

Stratification is the separation of overly wet or overvibrated concrete into horizontal layers, with increasingly smaller material concentrated toward the top. Stratification can result in concrete of nonuniform strength, weak areas, and disbonding of lift lines. Figure II-13 shows an example of stratification.

FIGURE II-13. STRATIFICATION

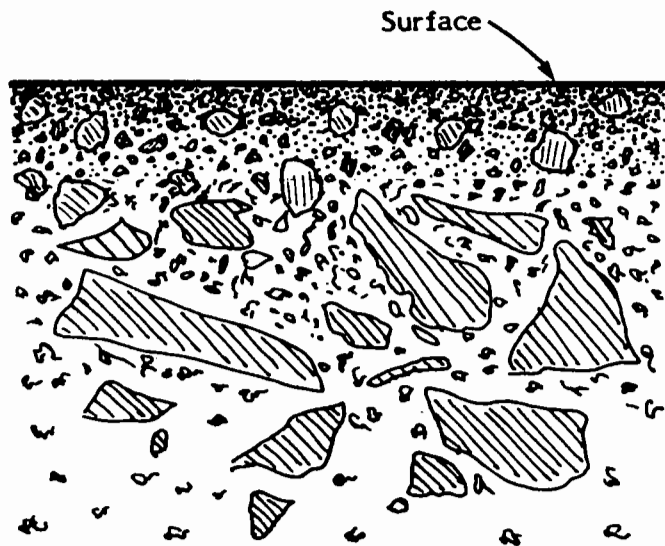

(Sectional View)

Form Slippage

Form slippage occurs when construction forms lack sufficient strength to withstand the pressure resulting from placement and vibration of the concrete. When the forms slip during construction, they can produce slightly offset blocks and uneven joints and surfaces. Sometimes form slippage is mistaken for misalignment of the concrete, which usually occurs well after construction.

Stains

Although discoloration and staining sometimes is associated with deterioration of concrete, most stains on concrete surfaces cause only an unpleasant appearance rather than damage. Stains may have natural causes, such as deposits from runoff water or deposits from corrosion of exterior steel. They may also result from construction or maintenance accidents (e.g., spilled oil, grease, paint, creosote, or asphalt).

INSPECTION OF CONCRETE AND MASONRY DAMS

II. INSPECTING FOR DEFICIENCIES: SURFACE DEFECTS

Impact Damage

Damage to a concrete surface sometimes results from mechanical impact. For example, the impact of a truck, boat, crane, or debris can mar or chip away a portion of the concrete surface. While such damage is localized, it can lead to other damage, such as freeze-thaw action, by permitting moisture to enter the concrete.

SURFACE DEFECTS: INSPECTION ACTIONS

Unlike cracks, which may penetrate well into the concrete, surface defects usually are shallow and do not usually present an immediate threat to the structure. However, by creating an opening to weather and other forces, they can lead to other more significant deterioration.

If you observe surface defects in the concrete, you should . . .

- ✓ Record their nature and location (remember SMPL!).
- ✓ Note the need for prompt repair of defects that might lead to more extensive deterioration (e.g., by allowing water to enter the concrete mass).

INSPECTION OF CONCRETE AND MASONRY DAMS

II. INSPECTING FOR DEFICIENCIES: DISPLACEMENT

WHAT IS DISPLACEMENT?

Displacement occurs when a structure or component moves from its originally constructed position. Although it may be hard to believe that a structure as massive as a dam can move, movements do occur when the reservoir is filled and emptied during successive seasons and as a result of seasonal temperature change or other causes. Such movements are taken into account in the design of a concrete dam.

Movement resulting in **displacement** can be caused by such factors as . . .

- . Abutment or foundation settlement or displacement.
- . Chemical reactions in the concrete.
- . Structural behavior of the dam.
- . Other applied loadings of exceptional magnitude (e.g., uplift pressures, earthquake, extreme temperature variations).

There are two main types of displacement in a concrete dam: misalignment and differential movement.

Misalignment

Misalignment is any variation from the original structural configuration.

Differential Movement

Differential movement occurs when one part of the structure moves with respect to adjacent parts of the structure. Figure II-14 presents examples of misalignment and differential movement.

FIGURE II-14. MISALIGNMENT AND DIFFERENTIAL MOVEMENT

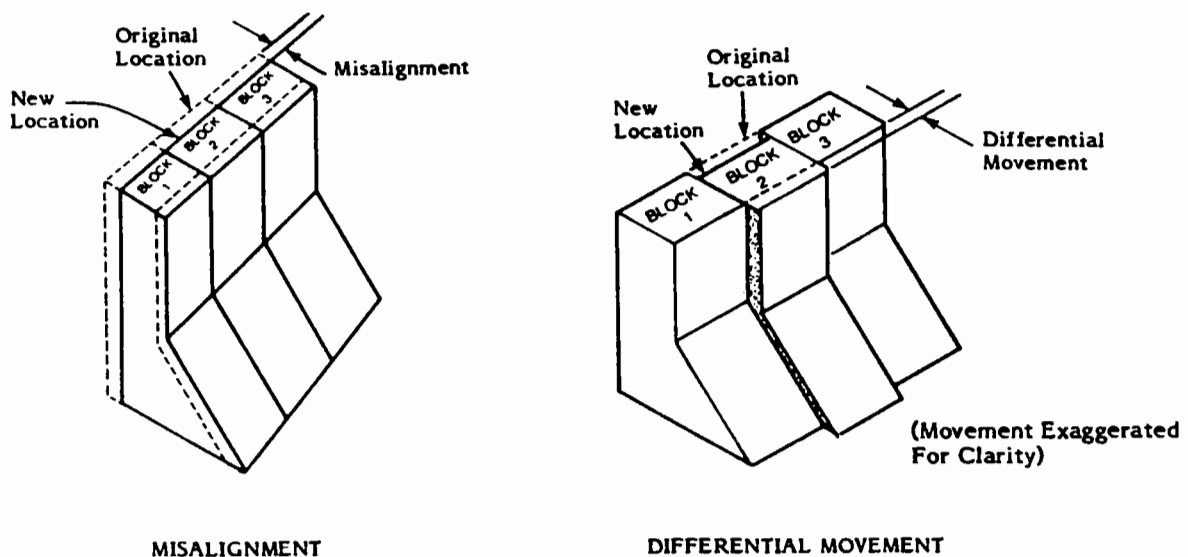

INSPECTION OF CONCRETE AND MASONRY DAMS

II. INSPECTING FOR DEFICIENCIES: DISPLACEMENT

DETECTING DISPLACEMENT

You are most likely to detect displacement by using sighting techniques at the crest of the dam. Differential movement most often appears as deflection at joints between adjacent blocks. Other indicators of displacement include . . .

- Volume change in the concrete
- Closing or opening of joints
- Loss of joint filler
- Cracking
- Debonding of lifts
- Tilting, shearing, or shifting of hardware or machinery
- Binding of gates

DISPLACEMENT: INSPECTION ACTIONS

Movement in and of itself is not bad. Small movements are of little concern and usually are considered in the design of the dam. Movement becomes significant when it has an adverse impact on the entire structure or on one or more of its parts.

 **INSPECTION TIP:** Significant changes--either in magnitude or in direction--should be evaluated immediately by an experienced, qualified engineer.

When you prepare for an inspection, you should . . .

- ✓ Study data from previous inspection reports or derived from surveys, if available.
- ✓ Focus on areas of the structure where evidence of movement has been noted.

When you inspect for displacement, you should . . .

- ✓ Check data from alignment instrumentation (e.g., triangulation points, plumbline wells, and deflectometers).
- ✓ Use sighting techniques along the crest of the dam to look for misalignment and differential movement.
- ✓ Inspect joints, hardware, and equipment for evidence of differential movement.
- ✓ Watch for structural cracking.
- ✓ Be alert for any changes in or new occurrences of displacement.

Continued . . .

INSPECTION OF CONCRETE AND MASONRY DAMS

II. INSPECTING FOR DEFICIENCIES: DISPLACEMENT

DISPLACEMENT: INSPECTION ACTIONS (Continued)

- ✓ For all displacement observed, records:
 - Location
 - Extent
 - Direction of displacement
 - Any other evidence of movement
 - Observations on date, time, and temperature.

 **INSPECTION TIP:** Make sure to record the relative water levels in the reservoir and downstream area.

Graphic or computer plots can be developed that allow you to distinguish between seasonal movement cycles and potential problems.

INSPECTION OF CONCRETE AND MASONRY DAMS

II. INSPECTING FOR DEFICIENCIES: LEAKAGE AND SEEPAGE

WHAT ARE LEAKAGE AND SEEPAGE?

Some agencies use the terms **leakage** and **seepage** interchangeably. For the purposes of this module . . .

- . **Leakage** is the flow of water through joints, cracks, and openings in hydraulic structures.
- . **Seepage** is the flow of water through the abutments or foundation of the dam.

CHARACTERISTICS OF LEAKAGE

Leakage normally occurs through joints or cracks in the concrete. The main causes of leakage are the following:

- . Cracks
- . Open joints
- . Broken seals
- . Leaking pipes or conduits
- . Deteriorated or defective concrete

Evidence of leakage can vary from a moist or wet surface to a concentrated flow of water. The most common indicators of leakage in a concrete dam are . . .

- . Wetness on the downstream face of the dam.
- . Wetness in the galleries.
- . Staining or buildup of sediments along joints and cracks.
- . Water spurting or running out of joints or cracks on the downstream face.
- . Significant flows in the gallery gutters, drainage system, and formed drains.

Leakage can result in an increased rate of deterioration of concrete, leaching of concrete, loss of mass, and reduced structural strength. Leakage can also cause excessive hydrostatic pressure within the dam, leading to overturning or sliding of blocks of the dam.

CHARACTERISTICS OF SEEPAGE

Seepage through the foundation and abutments can be caused by the following conditions:

- . Foundation deterioration.
- . Inadequate grout curtain, or insufficient or nonfunctioning foundation drains.
- . Joints or seams in the foundation or abutment material.

Continued . . .

INSPECTION OF CONCRETE AND MASONRY DAMS

II. INSPECTING FOR DEFICIENCIES: LEAKAGE AND SEEPAGE

CHARACTERISTICS OF SEEPAGE (Continued)

Evidence of seepage may include . . .

- . Wet areas on the abutments or foundation downstream of the dam.
- . Lush vegetative growth in an area downstream of the dam.
- . Instability of the slopes (e.g., slumps and slides) downstream of the dam.
- . Indications in instrument readings of undesirable hydrostatic pressure buildup.

The potential consequences of seepage include increased uplift pressure and differential movement in the dam. Seepage also has the potential for solutioning soluble rock materials or instability (sliding) of the abutment or foundation and thus weakening the foundation, with potential failure as a consequence in some cases. In very basic terms, excessive leakage and seepage can lead to loss of usable water.

MONITORING LEAKAGE AND SEEPAGE

All concrete dams leak and seep. The amount of leakage and seepage usually correlates with the level of the reservoir. Generally, as the level of the reservoir rises, the seepage flow rate increases. Temperatures also affect the amount of leakage: during cold weather, concrete contracts and joints or cracks open, increasing leakage.

As part of your inspection, you should monitor the rate and trends of leakage and seepage. You will need to check previous records of leakage and seepage **for comparable reservoir elevations** so that you can compare your findings. You are looking for . . .

- . Significant new leakage or seepage.
- . Major changes in leakage/seepage pattern or flow.
- . Turbidity in seepage.

Turbidity

Turbid water is cloudy, and is an indication that the foundation material may be eroding.

 **INSPECTION TIP:** Turbidity is cause for concern. Each time seepage is measured, clarity should be evaluated.

Taking Measurements

In some agencies, inspectors measure the amount of seepage and leakage. If previous records are not available for comparison, a program to collect flow data may need to be initiated. Don't forget to include the reservoir elevation each time flows are measured. This will help determine the cause of a change in the amount of flow.

Continued . . .

INSPECTION OF CONCRETE AND MASONRY DAMS

II. INSPECTING FOR DEFICIENCIES: LEAKAGE AND SEEPAGE

Taking Measurements (Continued)

There are various ways to take flow readings. The most common are . . .

- . The use of weirs (refer to the module on instrumentation)
- . The use of a bucket and stopwatch

Blocked Drains

In monitoring leakage, increased flows are not the only cause for concern. A noticeable **decrease** in seepage, if from **foundation** drains, can indicate that a drain is becoming blocked. Blocked drains can lead to deterioration of the concrete, flooding of galleries, increased uplift/hydrostatic pressures, and potential stability problems.

LEAKAGE AND SEEPAGE: INSPECTION ACTIONS

If you observe leakage or seepage, you should . . .

- ✓ Monitor the flow and record the following:
 - . Location and quantity or flow rate of all leakage and seepage at exit points.
 - . Occurrence of recent precipitation that may affect the appearance and quantity of seepage.
 - . Level of the reservoir at the time of the observation.
- ✓ Check seepage for turbidity.
- ✓ Document any suspected drain blockages. A recommendation that the drains be cleaned and/or redrilled may be warranted.

 **INSPECTION TIP:** Consult an experienced, qualified engineer if you observe significant new leakage or seepage, major changes in leakage/seepage pattern or flow, or turbidity in seepage.

INSPECTION OF CONCRETE AND MASONRY DAMS

II. INSPECTING FOR DEFICIENCIES: MAINTENANCE CONCERNS

WHAT ARE MAINTENANCE CONCERNS?

Maintenance includes the routine measures taken to protect and maintain the dam. Deficiencies associated with inadequate maintenance include . . .

- . Faulty drainage
- . Undesirable vegetation
- . Debris

In addition, the condition of certain features in the dam needs to be checked on a routine basis to ensure that the dam continues to be maintained in a sound condition. These features include . . .

- . Joint condition
- . Previous repairs
- . Environmental conditions

FAULTY DRAINAGE

We have discussed blocked drains in relation to leakage or seepage in the dam. Foundation drains should be sounded periodically or probed to detect the presence of mud or deposits in the drains. Foundation drains should be cleaned or redrilled periodically to prevent them from becoming clogged. Maintaining the foundation drains will ensure that uplift pressures will be relieved. Blockages in gutters also can prevent the proper functioning of the gallery drains in the dam.

Faulty Drainage: Inspection Actions

Depending on the procedures of your agency, you should . . .

- ✓ Observe the drain opening. Look for deposits blocking the opening.
- ✓ Probe or sound drains to detect blockages.
- ✓ Check flow records for changes in flow rates that may indicate faulty drainage.
- ✓ Walk the gallery system and note the condition of gutters. Report gutter blockages and recommend prompt cleaning.
- ✓ Check pressure gages.

INSPECTION OF CONCRETE AND MASONRY DAMS

II. INSPECTING FOR DEFICIENCIES: MAINTENANCE CONCERNS

UNDESIRABLE VEGETATION

Vegetation sometimes grows in the joints between concrete blocks. If not removed, such vegetation can cause deterioration of the seals and the concrete and result in increased leakage.

Undesirable Vegetation: Inspection Actions

During inspection you should . . .

- ✓ Report undesirable vegetation and recommend prompt removal.

DEBRIS

The buildup of debris can cause blockage of waterway intakes, impairing the proper functioning of the dam. Continuous wave action driving large debris against the upstream face of the dam also can lead to spalling and chipping of the concrete. Such surface damage can expose the concrete to further deterioration.

Debris: Inspection Actions

During inspection you should . . .

- ✓ Report large accumulations of debris around the dam and recommend prompt removal.
- ✓ Document any damage caused by the impact of debris against the dam.

JOINT CONDITION

As we discussed in Unit I, the vertical transverse contraction joints in a concrete dam are "designed cracks." The waterstops with which these joints are sealed can become unbonded through movement of the structure or can deteriorate from the effects of weathering. Loss of the seal can result in increased leakage through the joint.

Joint Condition: Inspection Actions

During your inspection you should . . .

- ✓ Check the condition of joint fillers and document any damage you observe.

INSPECTION OF CONCRETE AND MASONRY DAMS

II. INSPECTING FOR DEFICIENCIES: MAINTENANCE CONCERNS

PREVIOUS REPAIRS

Repairs to the concrete or mortar are common in older concrete and masonry dams. You may encounter patches over form-tie holes, repairs on cracked or deteriorated surfaces, or other concrete repairs. Such repairs need to be evaluated in terms of their ability to perform the function for which they were placed.

Previous Repairs: Inspection Actions

During your inspection, you should . . .

- ✓ Evaluate the condition of each repair in terms of its ability to perform its function.
- ✓ Note the quality of the patch material. If the repair is cracked, try to determine whether the cracking is confined to the patch or is caused by cracking in the material underneath the patch.
- ✓ Check the quality of the bond between the patch and the underlying material.
- ✓ Document your observations. **If repairs appear to be covering serious or worsening problems in the underlying material, consult a qualified engineer to evaluate the situation.**

ENVIRONMENTAL CONDITIONS

Throughout your inspection, it is important to note whether safe environmental conditions exist for personnel, particularly in interior spaces of the structure. You should pay particular attention to . . .

- ✓ Lighting
- ✓ Ventilation
- ✓ Safety around stairs and ladders

If lighting is inadequate, you are likely to miss some defects during your inspection. Inadequate ventilation--especially if there is a potential for buildup of hazardous gases or depletion of oxygen--can be a serious safety hazard. To ensure that you can safely examine all critical interior areas of the dam, be sure they are properly lit and ventilated.

INSPECTION OF CONCRETE AND MASONRY DAMS

II. INSPECTING FOR DEFICIENCIES: MAINTENANCE CONCERNS

Environmental Conditions: Inspection Actions

If you observe unsafe environmental conditions, you should . . .

- ✓ Report all unsafe conditions.
- ✓ Ensure that adequate lighting and ventilation are provided before continuing your inspection.

INSPECTION OF CONCRETE AND MASONRY DAMS

II. INSPECTING FOR DEFICIENCIES: UNIT EXERCISE

INSTRUCTIONS: Use the information presented in this unit to answer the following questions. When you have completed all of the questions, check your answers against those presented in the answer key. The answer key can be found immediately after this exercise.

1. Below each type of deficiency, write a possible cause.

. Cracks along joints:

. Pattern cracking:

. Spalling:

. Efflorescence:

2. Name four major causes of concrete deterioration.

. _____

. _____

. _____

. _____

Continued . . .

INSPECTION OF CONCRETE AND MASONRY DAMS

II. INSPECTING FOR DEFICIENCIES: UNIT EXERCISE

3. In the diagram below, label each crack in terms of its orientation on the dam.

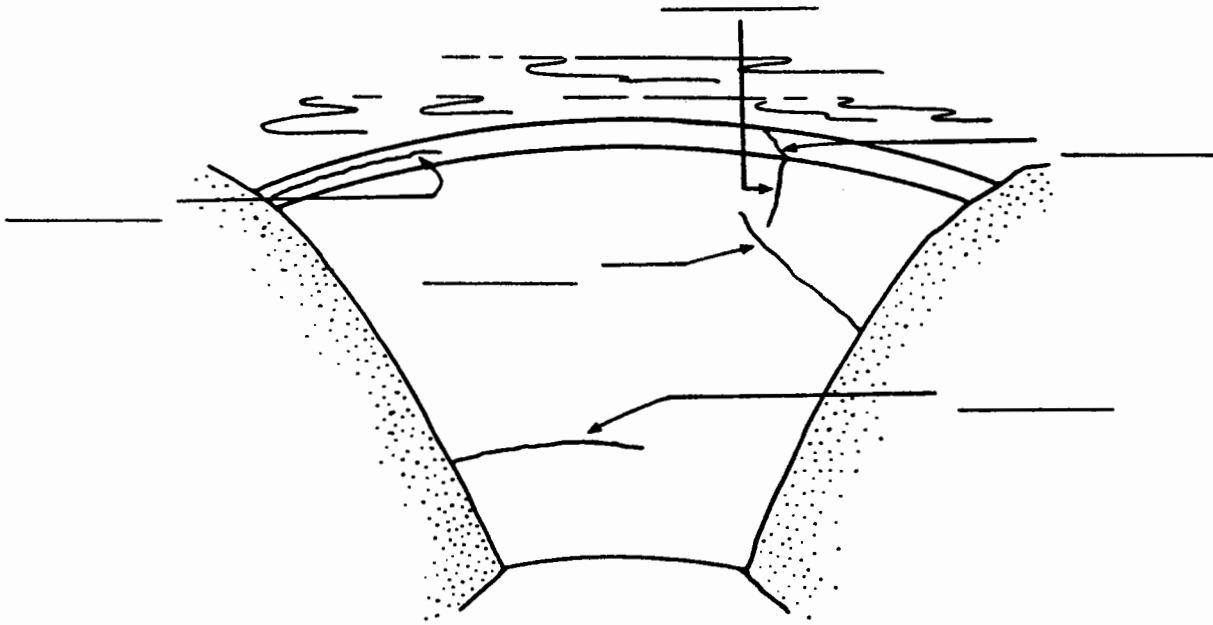

4. Name three types of surface defects.

- _____
- _____
- _____

5. List at least three causes of displacement.

- _____
- _____
- _____

Continued . . .

INSPECTION OF CONCRETE AND MASONRY DAMS

II. INSPECTING FOR DEFICIENCIES: UNIT EXERCISE

6. Below each type of deficiency, list at least two possible indicators.

. Structural cracking:

- . _____
- . _____

. Drying shrinkage cracks:

- . _____
- . _____

. Thermal cracking:

- . _____
- . _____

. Sulfate attack:

- . _____
- . _____

. Acid attack:

- . _____
- . _____

. Metal corrosion:

- . _____
- . _____

Continued . . .

INSPECTION OF CONCRETE AND MASONRY DAMS

II. INSPECTING FOR DEFICIENCIES: UNIT EXERCISE

7. Name at least two indicators of differential movement.

- _____
- _____

8. List three indicators of seepage.

- _____
- _____
- _____

9. Identify three places in a concrete dam where you might detect excess leakage.

- _____
- _____
- _____

10. Explain what turbidity of seepage water might indicate.

- _____
- _____
- _____

11. List at least two possible indicators of faulty drainage.

- _____
- _____

Continued . . .

INSPECTION OF CONCRETE AND MASONRY DAMS

II. INSPECTING FOR DEFICIENCIES: UNIT EXERCISE

12. When inspecting previous repairs, what should you check for? Name at least two things you should evaluate.

- _____
- _____

INSPECTION OF CONCRETE AND MASONRY DAMS

II. INSPECTING FOR DEFICIENCIES: UNIT EXERCISE—ANSWER KEY

INSTRUCTIONS: Compare your answers to those given below to see how well you learned the information presented in this unit.

1. Below each type of deficiency, write a possible cause.

Any of the following:

- . Cracks along joints:
 - **Structural movement**
 - **Volumetric change**
 - **Chemical reaction**
- . Pattern cracking:
 - **Chemical reaction**
- . Spalling:
 - **A blow to the concrete**
 - **Freeze-thaw action**
 - **Pressure (from corroding metal)**
 - **Expansion**
- . Efflorescence:
 - **Water seepage and leaching**

2. Name four major causes of concrete deterioration.

Any of the following items:

- . **Faulty concrete mixes**
- . **Thermal stresses**
- . **Freeze-thaw action**
- . **Chemical attack**
- . **Metal corrosion**
- . **Erosion**
- . **Cavitation**

Continued . . .

INSPECTION OF CONCRETE AND MASONRY DAMS

II. INSPECTING FOR DEFICIENCIES: UNIT EXERCISE—ANSWER KEY

3. In the diagram below, label each crack in terms of its orientation on the dam.

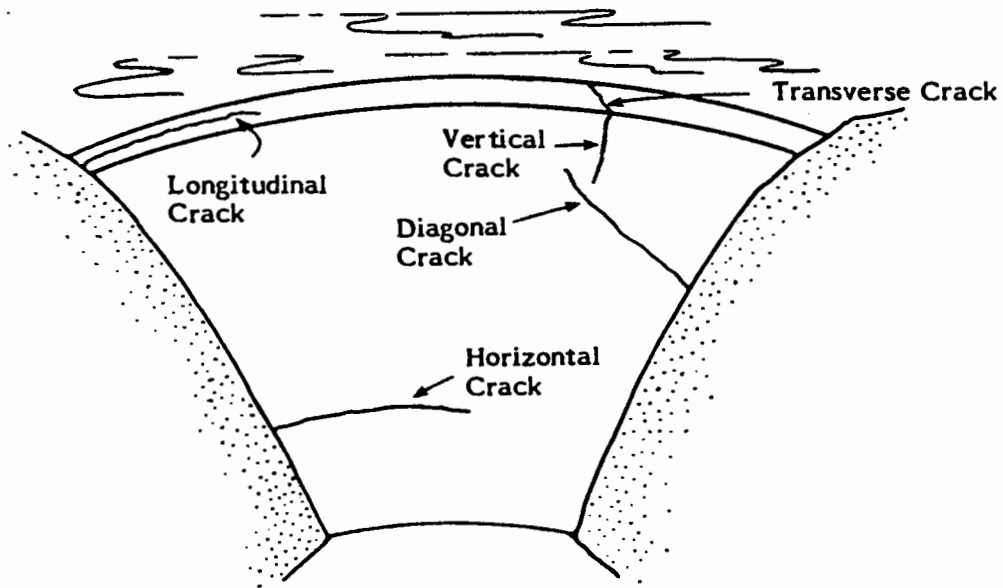

4. Name three types of surface defects.

Any of the following:

- . Honeycomb
- . Stratification
- . Form slippage
- . Stains
- . Impact damage

5. List at least three causes of displacement.

Any of the following:

- . Abutment or foundation settlement or displacement
- . Chemical reactions in the concrete
- . Structural behavior of the dam
- . Other applied loadings (uplift pressures, earthquake, extreme temperature variations)

Continued . . .

INSPECTION OF CONCRETE AND MASONRY DAMS

II. INSPECTING FOR DEFICIENCIES: UNIT EXERCISE—ANSWER KEY

6. Below each type of deficiency, list at least two possible indicators.

Any of the following:

- . Structural cracking:
 - Irregular cracks that run at an angle to major axes of the dam
 - Cracks that change direction abruptly
 - Widening of cracks over time
 - Displacement

- . Drying shrinkage cracks:
 - Orthogonal or blocky pattern
 - Fineness of cracks
 - Shallowness of cracks
 - No evidence of movement

- . Thermal cracking:
 - Orthogonal or blocking pattern
 - Deepness of cracks
 - Cracking down the faces from the crest
 - No evidence of movement

- . Sulfate attack
 - Cracking
 - Spalling
 - Scaling
 - Crazeing
 - Stains

- . Acid attack:
 - Efflorescence
 - Cracking
 - Spalling
 - Color change

- . Metal corrosion:
 - Straight, vertical, parallel cracks along rebar
 - Rust stains
 - Spalling
 - Exposed metal

Continued . . .

INSPECTION OF CONCRETE AND MASONRY DAMS

II. INSPECTING FOR DEFICIENCIES: UNIT EXERCISE--ANSWER KEY

7. Name at least two indicators of differential movement.

Any of the following:

- . Deflection at joints between adjacent blocks
- . Volume change in concrete
- . Closing or opening of joints
- . Loss of joint filler
- . Cracking
- . Debonding of lifts
- . Tilting, shearing, or shifting of hardware or machinery

8. List three indicators of seepage.

Any of the following:

- . Wet areas on abutments or foundation downstream of dam
- . Vegetation downstream of dam
- . Instability of slopes downstream of dam
- . Hydrostatic pressure buildup on instrument readings

9. Identify three places in a concrete dam where you might detect excess leakage.

- . Downstream face of dam
- . Joints and cracks
- . Gallery gutters and drainage system

10. Explain what turbidity of seepage water might indicate.

Turbid seepage may indicate that soil particles from the foundation are suspended in the water.

11. List at least two possible indicators of faulty drainage.

Any of the following:

- . Visible deposits blocking the openings
- . Blockages detected by sounding or probing
- . Changes in flow rates
- . Blocked gutters
- . Changes in pressure readings

Continued . . .

INSPECTION OF CONCRETE AND MASONRY DAMS

II. INSPECTING FOR DEFICIENCIES: UNIT EXERCISE--ANSWER KEY

12. When inspecting previous repairs, what should you check for? Name at least two things you should evaluate.

Any of the following:

- . Ability of the repair to perform its function
- . Quality of the patch material
- . Extent of any cracking (whether it is caused by cracking in the underlying material)
- . Quality of the bond between patch and underlying material

INSPECTION OF CONCRETE AND MASONRY DAMS

II. INSPECTING FOR DEFICIENCIES: SUMMARY

DEFICIENCIES TO LOOK FOR

In this unit information was presented on detecting deficiencies. Listed below are the key points to remember.

TYPE OF DEFICIENCY	LOOK FOR . . .
Cracking	Structural Cracks: <ul style="list-style-type: none">✓ Irregular cracks that run at an angle to major axes of the dam✓ Cracks that change direction abruptly✓ Wide cracks with noticeable displacement of concrete✓ Openings that widen with time✓ Cracks at corners of openings, along construction joints, and at discontinuities in foundation✓ Major new cracks✓ Cracks that have changed dramatically✓ Cracking over extensive areas
Concrete Deterioration	<hr/> <ul style="list-style-type: none">✓ Spalling✓ Efflorescence✓ Drummy concrete✓ Popouts✓ Pitting✓ Scaling✓ Sulfate Attack: Cracking, spalling, crazing, scaling, stains✓ Acid Attack: Efflorescence, cracking, spalling, color change✓ Alkali-Aggregate Reaction: Pattern cracking, efflorescence, incrustation, white rings around aggregate particles, gel exudation, disbonding at lift lines, binding of equipment✓ Metal Corrosion: Cracking along rebars, rust stains, spalling, exposed metal <hr/>

Continued . . .

INSPECTION OF CONCRETE AND MASONRY DAMS

II. INSPECTING FOR DEFICIENCIES: SUMMARY

DEFICIENCIES TO LOOK FOR (Continued)

TYPE OF DEFICIENCY	LOOK FOR . . .
Surface Defects	<ul style="list-style-type: none">✓ Honeycomb: Voids around aggregate✓ Stratification: Nonuniform layers of aggregate in concrete✓ Form Slippage: Uneven joints and surfaces✓ Stains✓ Impact damage <hr/>
Displacement	<ul style="list-style-type: none">✓ Displacement at joints between blocks✓ Volume change in concrete✓ Closing or opening of joints✓ Loss of joint filler✓ Cracking✓ Disbonding of lifts✓ Tilting, shearing, or shifting of hardware or machinery✓ Binding of gates <hr/>
Leakage And Seepage	<ul style="list-style-type: none">✓ Significant new leakage on downstream face or in galleries✓ Wetness in abutment or foundation adjacent to toe✓ Major changes in leakage/seepage pattern or flow✓ Water spurting or running out of joints or cracks✓ Turbidity of the seepage✓ Blocked drains <hr/>
Maintenance Concerns	<ul style="list-style-type: none">✓ Vegetation in joints between concrete blocks✓ Large accumulations of debris✓ Missing or deteriorated joint filler✓ Quality and condition of previous repairs✓ Adequacy of lighting and ventilation inside dam <hr/>

INSPECTION OF CONCRETE AND MASONRY DAMS

II. INSPECTING FOR DEFICIENCIES: SUMMARY

WHEN TO GET FURTHER ASSISTANCE

Several of the deficiencies covered in this unit are serious. If you observe any of the following deficiencies, you may need to consult with an experienced and qualified engineer.

- . Major new cracks or ones whose characteristics have changed dramatically from the previous inspection.
- . Cracks indicating movement that might be detrimental to the structure or to equipment operation.
- . Excessive water flowing through a crack, which cannot be handled by the drainage system.
- . Concrete deterioration that is major, sudden, extensive, or that has changed significantly since the previous inspection.
- . Significant misalignment or differential movement.
- . Significant new leakage or seepage.
- . Major changes in leakage/seepage pattern or flow.
- . Turbidity in seepage.
- . Repairs covering serious or worsening problems in underlying material.

Remember, whenever you are unsure whether or not a condition poses a threat to the safety of the dam, you should discuss your findings with an experienced and qualified engineer.

REMEMBER TO "SMPL"

If deficiencies are observed, remember to . . .

- S** **Sketch** what you have observed if a photograph would not capture important aspects of the deficiency.
- M** **Measure** and record the dimensions of the deficiency in your notes.
- P** **Photograph** the deficiency and describe its characteristics in your notes.
- L** **Locate** the deficiency in relation to some standard reference point (e.g., block or joint numbers, drain numbers, or other known features) and record the location in your notes.

II. INSPECTING FOR DEFICIENCIES: SUMMARY

VIDEO PRESENTATION



At this point you should watch the video presentation on the inspection procedures presented in this module. To watch the video presentation . . .

- . Turn on your video player.
- . Load the videocassette.

After watching the video presentation, rewind the videocassette and then return to the text and complete the Final Review Exercise.

FINAL REVIEW EXERCISE

INSPECTION OF CONCRETE AND MASONRY DAMS

FINAL REVIEW EXERCISE

INSTRUCTIONS: A situation is described below. After reviewing the situation, answer the questions using the information presented in this module.

Circle the letter next to the choice that you believe best answers the question. When you have completed all of the questions, check your answers against those presented in the answer key. The answer key can be found immediately following the last page of this exercise.

THE SITUATION: The San Cristobal Dam is a concrete gravity dam located in the Southwest. The structure is 1,257 feet long and 200 feet high, with a 200-foot overflow spillway section in the center controlled by large radial gates. The foundation abutments appear to be sound, but jointed. There is a good source of geologic data to support this contention. The dam was constructed in 1931. Highway 235 runs across the crest of the dam.

The San Cristobal Dam is a multipurpose dam used for both flood control and irrigation. This is the first time you have inspected the dam.

-
1. As you begin your inspection, usually where would be the best place to start?

2. At what location in a concrete dam would you expect to find evidence of cavitation?

Continued . . .

INSPECTION OF CONCRETE AND MASONRY DAMS

FINAL REVIEW EXERCISE

3. When you are inspecting the downstream face of the dam, you notice a wide crack that extends diagonally, zigzagging from a parapet to the left abutment. What is the most likely explanation?

4. In the situation described in the last item, what should you do?

5. When you strike a hammer against a concrete surface, you notice a hollow sound. What condition is the most likely explanation?

6. You observe D-cracking along several joints in the crest. What is a probable explanation?

7. You notice spalling in many places on the dam. List three probable causes of spalling.

•

•

•

Continued . . .

INSPECTION OF CONCRETE AND MASONRY DAMS

FINAL REVIEW EXERCISE

8. In a number of locations on the dam, you notice areas of long, fine cracks in a blocky pattern. When you probe with a pocket knife, they appear to be quite shallow. There is no evidence of concrete movement next to the cracks. What is the probable cause?

9. In the situation described in the last item, what should you do?

10. At what location would you be especially on the lookout for seepage?

11. You observe a large area of pattern cracking and efflorescence. Upon closer inspection, you notice a gel-like substance along the cracks. What is the probable cause?

12. In the situation described in the previous item, what is another clue you might look for to confirm the cause?

Continued . . .

INSPECTION OF CONCRETE AND MASONRY DAMS

FINAL REVIEW EXERCISE

13. You are concerned about construction joints at which the adjacent blocks appear to be slightly offset. What is a clue you might look for to determine whether the condition is caused by form slippage or differential movement?

14. List four possible causes of leakage in a concrete or masonry dam.

- ---
- ---
- ---
- ---

15. While inspecting a gallery, you observe a large flow of leakage in a construction joint. The history of leakage at this location has been confusing because at some times it flows profusely, but at other times there is no flow at all. What is a possible cause of the leakage?

16. When inspecting a concrete or masonry dam, under what conditions should you consult with an experienced, qualified engineer?

- ---
- ---
- ---

Continued . . .

INSPECTION OF CONCRETE AND MASONRY DAMS

FINAL REVIEW EXERCISE

17. You are walking the crest of the dam and you notice that the joint between blocks 16 and 17 appears to have closed. Cracking is visible parallel to and adjacent to the joint. What is a possible cause?

18. What observable condition might indicate that soil particles are being eroded from the foundation of a concrete dam?

19. You observe cracking on the face of the dam near an abutment. The cracking appears in a blocky pattern, and you are concerned about thermal cracking. In what way would thermal cracking differ from shrinkage cracking?

20. Personnel at the dam have reported a problem with the gates binding. List three probable causes of this problem.

•

•

•

FINAL REVIEW EXERCISE

ANSWER KEY

INSPECTION OF CONCRETE AND MASONRY DAMS

FINAL REVIEW EXERCISE—ANSWER KEY

INSTRUCTIONS: Compare your answers to those given below. For more information review the referenced text pages. Also, you may wish to review the video presentation.

1. As you begin your inspection, usually where would be the **best place to start?**

The crest of the dam

Beginning at the crest not only allows you to check alignment and to inspect upper portions of the dam, but it gives you a good vantage point from which to get an overview of the rest of the dam.

2. At what location in a concrete dam would you expect to find evidence of cavitation?

The spillway

Cavitation can occur in areas where concrete is subject to water moving at high velocities.

3. When you are inspecting the downstream face of the dam, you notice a wide crack that extends diagonally, zig-zagging from a parapet to the left abutment. What is the most likely explanation?

Structural cracking

Structural cracks are often characterized by an irregular path, abrupt changes in direction, width of the crack, and noticeable displacement of the concrete.

REFERENCES
Text Page: I-20
Text Pages: I-15 and II-17
Text Pages: II-5 and II-6

Continued . . .

INSPECTION OF CONCRETE AND MASONRY DAMS

FINAL REVIEW EXERCISE—ANSWER KEY

REFERENCES
Text Pages: II-9 and II-10
Text Page: II-12
Text Page: II-8

4. In the situation described in the last item, what should you do?

Consult an experienced, qualified engineer

Structural cracks are a serious concern because they can worsen with time and affect the structural integrity of the dam. An experienced, qualified engineer should be informed when structural cracking is observed.

5. When you strike a hammer against a concrete surface, you notice a hollow sound. What condition is the most likely explanation?

Drummy concrete

Drummy concrete has voids or weaknesses within the concrete that create a hollow sound when struck.

6. You observe D-cracking along several joints in the crest. What is a probable explanation?

Freeze-thaw action

D-cracking can be an early sign that freeze-thaw action is occurring.

Continued . . .

INSPECTION OF CONCRETE AND MASONRY DAMS

FINAL REVIEW EXERCISE--ANSWER KEY

7. You notice spalling in many places on the dam. List three probable causes of spalling.

Any three of the following:

- **Metal corrosion in reinforcing steel;**
- **Deterioration due to sulfate attack**
- **Freeze-thaw action on a joint or crack**
- **Mechanical damage**
- **Expansion of the concrete**

8. In a number of locations on the dam, you notice areas of long, fine cracks in a blocky pattern. When you probe with a pocket knife, they appear to be quite shallow. There is no evidence of concrete movement next to the cracks. What is the probable cause?

Shrinkage cracking

Shrinkage cracking is characterized by fine, shallow cracks that may be long and that appear in an orthogonal or blocky pattern. Although thermal cracks may have a similar appearance, they run much deeper.

REFERENCES

Text Pages: II-11, II-15, and II-16

Text Page: II-7

Continued . . .

INSPECTION OF CONCRETE AND MASONRY DAMS

FINAL REVIEW EXERCISE—ANSWER KEY

9. In the situation described in the last item, what should you do?

Document what you have observed

Shrinkage cracks should be documented but are not cause for immediate concern in a dam.

10. At what location would you be especially on the lookout for seepage?

Areas downstream of the dam

Seepage occurs in the dam foundation and abutments. Signs of excess seepage may appear as wet areas on the abutments or foundation downstream of the dam or as abundant downstream vegetation.

11. You observe a large area of pattern cracking and efflorescence. Upon closer inspection, you notice a gel-like substance along the cracks. What is the probable cause?

Alkali-aggregate reaction

Pattern cracking and efflorescence are typical of chemical attack. An exudation of gel is indicative of an alkali-aggregate reaction.

REFERENCES

Text Pages: II-9 and II-10

Text Page: II-28

Text Page: II-15

Continued . . .

INSPECTION OF CONCRETE AND MASONRY DAMS

FINAL REVIEW EXERCISE—ANSWER KEY

REFERENCES
Text Page: II-16
Text Pages: II-24 and II-25
Text Page: II-27

12. In the situation described in the previous item, what is another clue you might look for to confirm the cause?

Closing of expansion joints

Extreme alkali-aggregate reactions are characterized by growth of concrete, causing expansion joints to close.

13. You are concerned about construction joints at which the adjacent blocks appear to be slightly offset. What is a clue you might look for to determine whether the condition is caused by form slippage or differential movement?

Alignment of other exposed concrete surfaces

Whereas form slippage occurs during construction and does not involve movement of the concrete, differential movement causes movement at joints. It may be helpful to look for evidence of similar offset joints in other parts of the dam to determine whether movement has occurred.

14. List four possible causes of leakage in a concrete or masonry dam.

Any four of the following are possible causes:

- **Cracked concrete**
- **Open joints**
- **Broken seals**
- **Leaking pipes**
- **Defective concrete**
- **Movement in the dam**

Continued . . .

INSPECTION OF CONCRETE AND MASONRY DAMS

FINAL REVIEW EXERCISE—ANSWER KEY

REFERENCES
Text Pages: II-27 and II-31
Text Page: II-20
Text Pages: II-6 and II-16

15. While inspecting a gallery, you observe a large flow of leakage in a construction joint. The history of leakage at this location has been confusing because at some times it flows profusely, but at other times there is no flow at all. What is a possible cause of the leakage?

Broken waterstop

If a waterstop is broken, water could be leaking through the joint. Intermittent leakage could be associated with different reservoir elevations or changes in temperature.

16. When inspecting a concrete or masonry dam, under what conditions should you consult with an experienced, qualified engineer?

Any concrete deterioration that is **major, sudden, extensive, or significantly changed**, or that appears to **affect the integrity of the structure** should be called to the immediate attention of an engineer.

17. You are walking the crest of the dam and you notice that the joint between blocks 16 and 17 appears to have closed. Cracking is visible parallel to and adjacent to the joint. What is a possible cause?

Expansion of concrete

You should suspect expansion of the concrete, which could indicate chemical attack.

Continued . . .

INSPECTION OF CONCRETE AND MASONRY DAMS

FINAL REVIEW EXERCISE--ANSWER KEY

REFERENCES
Text Pages: II-28 and II-29
Text Pages: II-4, II-7, and II-15
Text Pages: II-8, II-16, and II-25

18. What observable condition might indicate that soil particles are being eroded from the foundation of a concrete dam?

Turbid seepage

Cloudiness or turbidity of seepage water can indicate piping of soil particles from faults in the foundation rock.

19. You observe cracking on the face of the dam near an abutment. The cracking appears in a blocky pattern, and you are concerned about thermal cracking. In what way would thermal cracking differ from shrinkage cracking?

Depth of cracks

Thermal cracking, which is caused by differential cooling during concrete construction, tends to run much deeper than shrinkage cracking, which occurs during subsequent wet-dry cycles.

20. Personnel at the dam have reported a problem with the gates binding. List three probable causes of this problem.

- **Alkali-aggregate reaction**
- **Differential movement**
- **Freeze-thaw action**

Alkali-aggregate reaction causes expansion of concrete, which could affect gate operation. Concrete moved by differential movement can put pressure on gate mechanisms. Freeze-thaw action can also affect equipment by causing cracking, spalling, and concrete deterioration, which could interfere with gate alignment.

APPENDIX A

GLOSSARY

INSPECTION OF CONCRETE AND MASONRY DAMS

GLOSSARY

ABUTMENTS - Those portions of the valley sides to which the ends of the dam join, and also those portions beyond the dam that might present seepage or stability problems.

ADIT - A gallery that is used for entrance to a gallery system or that serves as a connecting passageway between galleries or other features in the dam.

ARCH DAM - A concrete dam that is arched upstream so as to transmit the major part of the water load to the abutments.

BUTTRESS DAM - A dam consisting of a watertight element supported at intervals on the downstream side by a series of buttresses. Buttress dams can take many forms, such as a flat slab, massive head buttress, or multiple arch buttress.

CHECKING - Development of shallow cracks at closely spaced but irregular intervals on the surface of mortar or concrete.

COMPOSITE DAM - A dam that includes both a concrete section and embankment sections.

CONSTRUCTION JOINT - The interface between two successive placings of concrete where bond is intended.

CONTRACTION JOINT - Joints between concrete blocks that are designed to prevent the formation of tension cracks as the structure undergoes volumetric shrinkage due to temperature drop. Contraction joints are vertical and run transversely through the dam, from the foundation to the crest.

CREST - The top surface of the dam or high point of the spillway control section.

D-CRACKING - Progressive formation of a series of fine cracks at rather close intervals, often in random D-shaped patterns along a joint.

DEFICIENCY - An anomaly or condition that affects or interferes with the proper and safe operation of the dam.

DOWNSTREAM FACE - The inclined surface of a concrete dam that faces away from the reservoir.

DRUMMY CONCRETE - Concrete that has a void or weakness within the concrete.

EFFLORESCENCE - A deposit of salts that is leached from within the concrete and deposited on the surface.

EXPANSION JOINTS - Joints placed in a concrete structure primarily to accommodate volumetric expansion due to temperature rise.

FORMED DRAIN - A vertical drain hole that is formed in concrete during construction to intercept water that may leak into the dam along horizontal joints or through the concrete.

INSPECTION OF CONCRETE AND MASONRY DAMS

GLOSSARY

FOUNDATION DRAIN - A drain drilled into the foundation downstream of the grout curtain to collect seepage water and carry it up to the internal drainage system where it can be disposed of.

GALLERY - A passageway in the body of a dam used for inspection, foundation grouting, and/or drainage. Galleries may run longitudinally or transversely, horizontally or on a slope.

GRAVITY DAM - A concrete dam that relies on its weight and internal strength for stability.

GROUT CURTAIN - A zone, created by drilling a line of holes deep in the foundation near the heel of the dam, into which grout is injected to reduce seepage under or around a dam.

HEEL - The junction of the upstream face of a concrete dam with the ground surface.

HONEYCOMB - Voids left in concrete when mortar fails to fill the spaces between coarse aggregate particles. Also called **rockpocket**.

LEAKAGE - The undesirable flow of water through joints, cracks, and openings in hydraulic structures.

LIFT LINE - Horizontal construction joints that are created when new concrete is placed on a previous lift.

MASONRY DAM - A dam constructed mainly of stone, brick, or concrete joined with mortar.

OUTLET WORKS - A system of dam components that regulates or releases water impounded by a dam. Components of an outlet works include an entrance channel, intake structure, conduit, gate or valve housing, energy dissipators, and return channel.

PENSTOCK - A pipeline or pressure conduit leading from a headrace or reservoir to power-producing turbines. Because of the possibility of sudden load changes, a penstock is designed to withstand pressure surges.

PITTING - Development of relatively small cavities in the concrete surface.

POPOUT - A small portion of concrete surface that breaks away, due to internal pressure, leaving a shallow, conical depression.

RESERVOIR - The body of water impounded by a dam.

ROLLER-COMPACTED CONCRETE (RCC)- A type of concrete construction in which a mixture of well-graded gravel fill with low cement content is laid in layers and compacted using heavy equipment.

INSPECTION OF CONCRETE AND MASONRY DAMS

GLOSSARY

SCALING - Flaking or peeling away of the surface of concrete or mortar.

SEEPAGE - The passage of water through embankment, foundation, or abutment material.

SPALLING - The loss of chunks of concrete from a surface, usually because of compression, impact, or abrasion.

SPILLWAY - A structure over or through which flood flows are discharged. If the rate of flow is controlled by mechanical means, such as gates, it is considered a controlled spillway. If the elevation of the spillway crest is the only control, it is considered an uncontrolled spillway.

STRATIFICATION - Separation of concrete into horizontal layers, with increasingly smaller material concentrated toward the top.

STRUCTURAL CRACK - A crack that calls into question the structural integrity of an element of a dam.

TOE OF DAM - The junction of the downstream slope of a dam with the ground surface; also referred to as the **downstream toe**. For an embankment dam, the junction of the upstream face with the ground surface is called the **upstream toe**.

TURBIDITY - The discoloration or cloudiness of seepage water proportionate to the amount of soil particles suspended in the water.

UPSTREAM FACE - The vertical or near-vertical surface of a concrete dam that is in contact with the reservoir.

APPENDIX B
REFERENCES

INSPECTION OF CONCRETE AND MASONRY DAMS

REFERENCES

Concrete Manual, A Water Resources Technical Publication. U.S. Department of the Interior, Bureau of Reclamation, Eighth Edition, Revised, 1981.

Dam Safety Manual. State Engineer's Office, State of Colorado, June 1983.

Design of Arch Dams, A Water Resources Technical Publication. U.S. Department of the Interior, Bureau of Reclamation, 1977.

Design of Gravity Dams, A Water Resources Technical Publication. U.S. Department of the Interior, Bureau of Reclamation, 1976.

Design of Small Dams, A Water Resources Technical Publication. U.S. Department of the Interior, Bureau of Reclamation, Third Edition, 1987.

Engineering Condition Survey of Concrete in Service. Richard L. Stowe and Henry T. Thornton, Jr. Department of the Army, 1984.

Guide for Making a Condition Survey of Concrete in Service. American Concrete Institute, ACI Committee 201, Reaffirmed 1979.

Handbook of Dam Engineering. Alfred R. Golze, editor, Van Nostrand Reinhold Company, 1977.

Inspection, Maintenance and Rehabilitation of Old Dams. Proceedings of the Engineering Foundation Conference. American Society of Civil Engineers, 1973.

Practices for Evaluation of Concrete in Existing Massive Structures for Service Conditions. American Concrete Institute, ACI Committee 201, 1979.

Safety Evaluation of Existing Dams, A Water Resources Technical Publication. U.S. Department of the Interior, Bureau of Reclamation, Revised Reprint, 1983.

Safety of Existing Dams - Evaluation and Improvement. National Research Council, National Academy Press, 1983.

Suggested Procedures for Safety Inspections of Dams. Joel A. Reed. Ohio Department of Natural Resources, Division of Water, Dam Safety and Water Engineering Section, 1987.