



# **Structural Ice Control**

## **Review of Existing Methods**

Andrew M. Tuthill

July 1995

***Abstract***

This report is a comprehensive review of structural ice control methods in use worldwide today. The structures are grouped according to the purpose of the ice control. Categories are sheet ice retention, breakup ice control and ice diversion. The focus is on the recent performance of the structures. Innovative solutions that could be applied to river confluence ice problems also receive special attention. The report reviews the state of the art in structural ice control, addressing the ranges as well as the limits of application of methods in use today.

For conversion of SI units to non-SI units of measurement consult *Standard Practice for Use of the International System of Units (SI)*, ASTM Standard E380-93, published by the American Society for Testing and Materials, 1916 Race St., Philadelphia, Pa. 19103.

This report is printed on paper that contains a minimum of 50% recycled material.

# Special Report 95-18

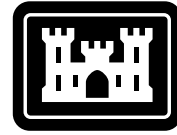

**US Army Corps  
of Engineers**

Cold Regions Research &  
Engineering Laboratory

## **Structural Ice Control Review of Existing Methods**

Andrew M. Tuthill

July 1995

Prepared for  
OFFICE OF THE CHIEF OF ENGINEERS

Approved for public release; distribution is unlimited.

## **PREFACE**

This report was prepared by Andrew M. Tuthill, Research Hydraulic Engineer, Ice Engineering Research Division, Research and Engineering Directorate, U.S. Army Cold Regions Research and Engineering Laboratory. Funding was provided by the Office of the Chief of Engineers under the Civil Works program, Work Unit 32926, which is part of the River Confluence Ice Program.

This review describes a broad range of existing structural solutions to a wide variety of ice control problems. Although methods that might apply to river confluence ice problems receive some extra attention, the structural techniques described in this review are not limited to confluence ice situations. A second phase of the work unit will examine and select confluences with known ice problems for detailed analysis. A third phase will combine the first two by adapting and applying structural methods to specific confluence ice problems. Where possible, the methods being developed will be verified through field demonstration projects, done in conjunction with Corps Districts and municipalities. The work unit's final product, design guidance for structural ice control at river confluences, will appear as an engineering manual chapter.

The contents of this report are not to be used for advertising or promotional purposes. Citation of brand names does not constitute an official endorsement or approval of the use of such commercial products.

## CONTENTS

Preface .....	ii
Introduction .....	1
Background .....	1
Sheet ice retention structures .....	2
Purposes .....	2
Types .....	3
Examples .....	3
Breakup ice control structures .....	14
Purpose .....	14
Types .....	14
Examples .....	14
Pack ice barriers .....	18
Ice diversion structures .....	18
Ice diversion at hydropower intakes in northern Europe .....	19
Ice diversion at locks .....	20
Analysis and conclusions .....	20
General conclusions .....	21
Applicability of structural ice control methods to river confluence situations .....	22
Channel depth and water current velocity at selected structures .....	22
Literature cited .....	24
Appendix A: Inventory of existing structures .....	27
Abstract .....	31

## ILLUSTRATIONS

### Figure

1. Ice island on Lake St. Peter .....	3
2. Montreal Harbor ice control structure .....	4
3. Lake Erie ice boom .....	5
4. Locations of ice booms on the Beauharnois Canal .....	5
5. St. Marys River ice boom .....	5
6. Boom on the Beauharnois Canal, constructed of double steel pontoons .....	6
7. Ice booms on the International Section of the St. Lawrence River .....	7
8. Two boom configurations tested at Salmon, Idaho .....	8
9. Allegheny River ice boom .....	9
10. Ice control dam on the Caudiere River at St. Georges, Quebec .....	11
11. Ice control weir on the Israel River, Lancaster, New Hampshire, July 1994 .....	11
12. Ice control weir on Oil Creek, upstream of Oil City, Pennsylvania .....	11
13. Fence boom installed on the Mascoma River, Lebanon, New Hampshire .....	12
14. Ice fence on the Penkeniuppi River in northern Japan .....	12
15. Tension weir on the Ompompanoosuc River at Union Village, Vermont .....	13
16. Frazil collector lines being tested on the Mascoma River, 1981 .....	13
17. Credit River ice control structure following breakup, March 1994 .....	15

Figure

18. Cut granite block ice control structure in Hardwick, Vermont, following breakup, March 1995 .....	15
19. Weir with piers ice control structure on the Ste. Anne River, St. Raymond, Quebec .....	16
20. Proposed ice control structure for Cazenovia Creek near Buffalo, New York ...	17
21. Rock-filled timber cribs upstream of the dam at Cherryfield, Maine .....	17
22. Spillway barrier at the outlet of the Sigalda Reservoir in Iceland .....	18
23. Pack ice barrier, Saroma Lagoon, Sea of Okhotsk .....	18
24. Ice sluice at the intake to the Burfell Power Station, Iceland .....	19
25. Chief Joseph shear boom on the Columbia River at Bridgeport, Washington ...	20
26. Barges used to shear ice away from a lock entrance .....	20
27. Depth vs. average velocity for various types of ice control structures .....	23

**TABLES**

Table

1. Applicability of structural ice control methods to river confluence situations...	22
2. Channel depth and water current velocity at selected structures.....	23

# Structural Ice Control

## Review of Existing Methods

ANDREW M. TUTHILL

### INTRODUCTION

Structural solutions exist for a wide range of river ice problems. This report reviews a variety of structural ice control methods in use today, focusing on recent performance. A main goal is to determine which areas of structural ice control are well developed and understood at present, and which ice problems do not lend themselves to a solution by current structural methods. It is also hoped that the information assembled through this work will provide guidance in selecting and adapting structural ice control methods for specific confluence ice problems.

Ice control research and development during the last three decades has concentrated on sheet ice retention methods. Much of this work is described by Perham (1983) and Appendix B of the Ice Engineering Manual (U.S. Army Corps of Engineers 1985). The difficult problem of breakup ice control has received less attention, particularly on larger rivers. This report serves as a supplement to Perham's 1983 review, emphasizing recent developments in structural ice control as well as methods that could be applied to ice problems characteristic of river confluences. Few constraints have been placed on geographic location, scale or structure type. Locations include sites in the northern United States, Canada, northern Europe and Japan.

A background section summarizes past reviews on structural ice control. Structures are then placed in three categories according to their main purpose: sheet ice retention, breakup ice control or ice diversion. The ice control objectives of each category are discussed, along with general design considerations and typical ranges

of application. Within each category, examples then illustrate a variety of structure types. A conclusions section then summarizes the current state of knowledge in the field of structural ice control, pointing to areas where new methods or applications might be possible. The conclusions also assess the applicability of selected structural methods to various confluence ice situations. The typical hydraulic conditions of channel depth and water current velocity for different types of structures are also considered in the conclusions. Finally, Appendix A, an inventory of structures, serves as a database, containing tabular information on design, construction materials, hydraulic conditions and recent performance.

### BACKGROUND

The last three decades have seen much development in the field of structural ice control. The following is a brief summary of the general literature on structural ice control methods. Literature relating to single structures will be cited where appropriate later in the report.

"Winter Regime of Rivers and Lakes" by Michel (1971) provides good background on river ice processes affecting the design of dams and booms to control frazil and breakup ice. During the sixties and seventies, the navigation and hydropower interests, along with various government agencies in the U.S. and Canada, fostered the successful development of sheet ice retention methods on the St. Lawrence River and the connecting channels of the Great Lakes. Perham (1983) and Appendix B of the Ice Engineering Manual (U.S. Army Corps of Engineers 1985) provide descriptions of many of these

structures, and Ashton (1986) contains a brief version of Perham's review. At the same time, structural ice control techniques were evolving in northern Europe, the main focus being on hydropower. Roen and Tesaker (1988) discussed a range of ice problems and structural solutions at hydroelectric plants in Norway, presenting five case studies. At a more general level, Carstens and Tesaker (1987) presented a general inventory of ice problems on rivers, listing possible structural solutions. Calkins (1984) presented six case studies of ice jam problems on rivers in the U.S. and Canada, in outline form, briefly describing existing and proposed structural solutions.

A project headed by Harold Belore of the consulting firm Cumming-Cockburn and Associates, Ltd. (1986a) produced a comprehensive overview of ice control methods on small rivers in Canada where dams, weirs, piers and booms were used successfully to mitigate both freeze-up and breakup ice problems. Belore et al. (1990) also described a variety of structural methods, ranging from sheet ice control structures on the St. Lawrence River to weir-and-pier structures designed to control breakup ice on smaller Canadian rivers. Deck (1984) briefly presented a structural solution to the ice jam problems at Oil City in Pennsylvania. Deck and colleagues later drew on the Canadian experience with weir-and-pier structures to develop a design for a proposed ice control structure on Cazenovia Creek near Buffalo, New York (Gooch and Deck 1990).

Jain et al. (1993) contains a summary of ice control methods, describing the point at which a nonstructural solution such as flow control may become more feasible than a structural one on the larger rivers in the U.S. The innovative methods of controlling pack ice off the northern coast of Japan described by Saeki (1992) are mentioned in this report since they could possibly be applied to ice problems at the confluences of large rivers in the U.S.

So why write this review? At the very least, this effort is of value since it assembles much of the relevant information in one place. In addition, this report is more complete, taking a broader perspective than much of the general literature. A single information source may help eliminate the need to rediscover previously used methods. Other than the focus on structural ice control methods that could be applied to river confluences, this review is not limited to any particular size or type of river or structure nor is it constrained to any specific geographical region.

## **SHEET ICE RETENTION STRUCTURES**

Sheet ice retention structures promote ice formation on water bodies with relatively low surface velocities ( $\leq 2.3$  ft/s), low energy slopes and low Froude numbers ( $\leq 0.08$ ) (Perham 1983). Hydraulic conditions must allow for arriving ice to accumulate against the structure (juxtapose), rather than be dragged beneath the surface during the formation period. The cover typically progresses from the structure in the upstream or windward direction, and arriving ice may be in the form of frazil, floes or brash. The main goal of a sheet ice retention structure is to initiate ice cover formation. Once a solid cover has formed, the structure is usually not designed to add to the cover's overall stability. Although sheet ice retention structures are typically not designed to retain breakup ice, they may make breakup less severe by delaying the breakup of the upstream ice cover until the downstream ice has had a chance to clear out.

### **Purposes**

Retention or stabilization of a sheet ice cover has a number of positive effects. Stabilizing the shore ice on a river or lake reduces the ice volume supplying potential ice jams at locations downstream. As an added benefit, a stable shore ice zone protects the shoreline and shoreline structures from the destructive effects of offshore ice movement. In cases of winter navigation, stabilization of the ice along the channel sides minimizes the ice volume in the navigation channel and increases the channel's ice-flushing capacity. At lake-to-river transition areas, special booms, some with navigation openings, have been developed to prevent lake ice from entering and clogging the narrower downstream channels.

Formation booms may be placed on a river or canal to stop the downstream transport of frazil ice and promote the upstream progression of an ice cover. The hydropower industry in northern climates has used this type of boom extensively to promote the rapid formation of an ice cover upstream of their intakes early in the ice season, minimizing ice-related head losses and increasing winter power production. Though not specifically designed for the purpose, these booms, alone or in series, may help prevent ice floes from piling up and damaging hydropower intakes at breakup. In addition to increasing the reliability of winter hydro production, formation booms have effectively reduced the ice jam



threat to towns and properties along rivers by capturing frazil at favorable locations upstream of the historic ice jam sites.

### Types

A wide variety of sheet ice retention structures exist, many of which are well described and illustrated by Perham (1983) and Appendix B of the Ice Engineering Manual (U.S. Army Corps of Engineers 1985). The list includes conventional floating booms, rigid booms, weirs, groins and artificial ice islands. Many structures such as dams, bridge piers and tower foundations, although not specifically designed to control ice, do serve that purpose. In addition, piers, piles and pile clusters (dolphins) and, in some cases, sunken vessels have been used to stabilize a sheet ice cover.

### Examples

Examples are presented in six groups, according to the general type of structure and the purpose of the ice control. The first group covers sheet ice control methods used on large rivers with winter-long navigation. In the second group, examples of ice control at channel constrictions and lake-river confluences are presented. Ice booms and winter hydropower is the topic of the third group. The fourth group deals with formation booms to prevent ice jam flooding along rivers. Sink-and-float booms are the topic of the fifth group. Examples of sheet ice retention using weirs, groins and dams form the final group.

#### *Ice control on rivers and waterways with winter-long navigation*

On the lower St. Lawrence River, where winter-long navigation extends as far upstream as Montreal, the ice management program depends in part on structural methods to retain and stabilize sheet ice. Here the ice control effort has the goals of preventing the ice jams that have historically flooded Montreal and of ensuring safe and efficient navigation to the port of Montreal. At Lake St. Peter, 45 miles downstream from Montreal, the St. Lawrence River widens and flattens, significantly reducing the river's ice conveyance capacity. Here, nine artificial islands effectively stabilize the ice between the shore and the centrally located, dredged navigation channel. These islands, constructed of quarried rock, have base diameters of 130 ft and are spaced 2500 ft apart. Fig-



a. Ice island along the northern edge of the navigation channel to stabilize shore ice.



Figure 1. Ice island on Lake St. Peter.

ure 1 shows an ice island on Lake St. Peter retaining sheet ice during the early spring. Perham (1983), Appendix B of the Ice Engineering Manual (U.S. Army Corps of Engineers 1985) and Lawrie (1972) provided more detailed information. The five islands on the south side of the navigation channel were constructed after 1985. Initial construction and maintenance of the ice islands are costly. The islands must periodically be topped off to compensate for continual settlement in the soft lake sediments. Upstream of Montreal, three similar islands in Lake St. Louis prevent floes from entering the navigation channel during the early part of the navigation season (Perham 1983).

The four booms in the northeast corner of Lake St. Peter, depicted in Appendix B of the Ice Engineering Manual (U.S. Army Corps of Engi-

neers 1985), were carried away in the late seventies by a large floe that rotated up from the southwest quadrant of the lake. After this incident the booms were not installed again. Upstream of Lake St. Peter, 2300- and 3300-ft-long booms stabilize the ice cover along the river's left side at Lanoraie and Lavaltrie. Most of the booms are of conventional design, with 14-in.  $\times$  22-in.  $\times$  30-ft timbers connected to a series of cables with 400-ft-long spans. However, several test spans made up of 30-in.-diameter cylindrical steel pontoons are showing promise in terms of increased capture efficiency and reduced cost.\*

The overall goal of the islands and booms is to allow as little ice as possible to enter the navigation channel. The structural measures make up only part of the overall ice management scheme, however. Continual ice breaking and flushing efforts, combined with routine airborne surveillance, are also critical.

The Montreal Harbor ice control structure (ICS), located at the upstream limit of winter navigation on the St. Lawrence, consists of a row of concrete piers, spaced at 88-ft centers, over a total width of 1.3 miles. Figure 2 is an aerial view of the structure. Originally steel pontoons (5.5  $\times$  5.8 ft in cross section) floated in guide slots



Figure 2. Montreal Harbor ice control structure. (From Lawrie 1972.)

between the piers with the goal of initiating an ice cover as early as possible. It was later found that the pontoons were unnecessary, since the piers alone promoted the formation of a stable ice cover in Laprairie Basin, upstream of the structure. This discovery was fortunate, since

operation and maintenance of the pontoons were costly and difficult. Once formed, the ice cover behind the structure prevents floes and brash from contributing to potential jams in the navigation channel downstream of the city. In addition, the cover behind the ICS traps and stores much of the frazil generated in the Lachine rapids upstream of Montreal. Before construction of the Montreal Harbor ICS, the ice cover on Laprairie Basin formed only after the natural ice cover had progressed from Lake St. Peter up to Montreal (Donnelly 1966). Should the cover progress as high as Montreal, the ICS was intended to capture arriving ice from upstream to reduce the ice jam flood threat to the city. Due to successful ice breaking and flushing efforts by the Canadian Coast Guard, the ice cover has not reached the city since winter-long navigation began in the mid-sixties, so the structure has never been tested in this worst-case scenario. At a cost of \$16 million Canadian in 1965, the Montreal Harbor ICS is possibly the most expensive ice control structure ever built (Donnelly 1966, Lawrie 1972).

On the Trollhatte Canal in Sweden, ice booms, rock-filled cribs and dolphins are used to stabilize sheet ice along the sides of the navigation channel. As with the lower St. Lawrence, winter-long navigation is the goal, from Sweden's west coast to ports on Lake Vanern. Ice breaking and flushing, bubblers and lock wall heaters along with airborne surveillance complement the structural ice control methods (Solve 1986).

#### *Ice control at lake-river confluences and channel constrictions*

Lake-to-river confluences present a special ice control problem. Although there is a tendency for ice arches to form naturally at these locations, wind and wave effects, as well as vessel passages, can disrupt arch formation, causing lake ice to enter and sometimes jam in the narrower channel downstream.

The Lake Erie ice boom, located near Buffalo, New York (Fig. 3), prevents, to a large degree, lake ice from entering the Upper Niagara River. The 8800-ft-long boom has 22 spans, each 400 ft long; each span is made up of 13 timbers, each 16 in.  $\times$  22 in.  $\times$  30 ft. Occasionally, during the early winter, wind-driven lake ice in the 4- to 8-in. thickness range will override the boom, however. These lake ice runs may result in massive jams in the Upper Niagara River, causing flood-

\* Personal communication with Brian Morse, Canadian Coast Guard, April 1994.



Figure 3. Lake Erie ice boom.

ing and reductions in hydropower production at the plants at Niagara Falls. The New York Power Authority and Ontario Hydro, in conjunction with the Canadian consulting firm Fleet Technology, are presently researching alternatives for replacing the 8800-ft-long conventional timber boom with a more reliable structure. The circular steel pontoons being tested on Lake St. Peter are being considered for the Lake Erie boom (Abdelnour et al. 1994, Crissman 1994).

The Lake St. Francis ice boom, on the St. Lawrence River in Quebec, prevents wind-driven lake ice from entering the upstream end of the Beauharnois Canal during the late winter and

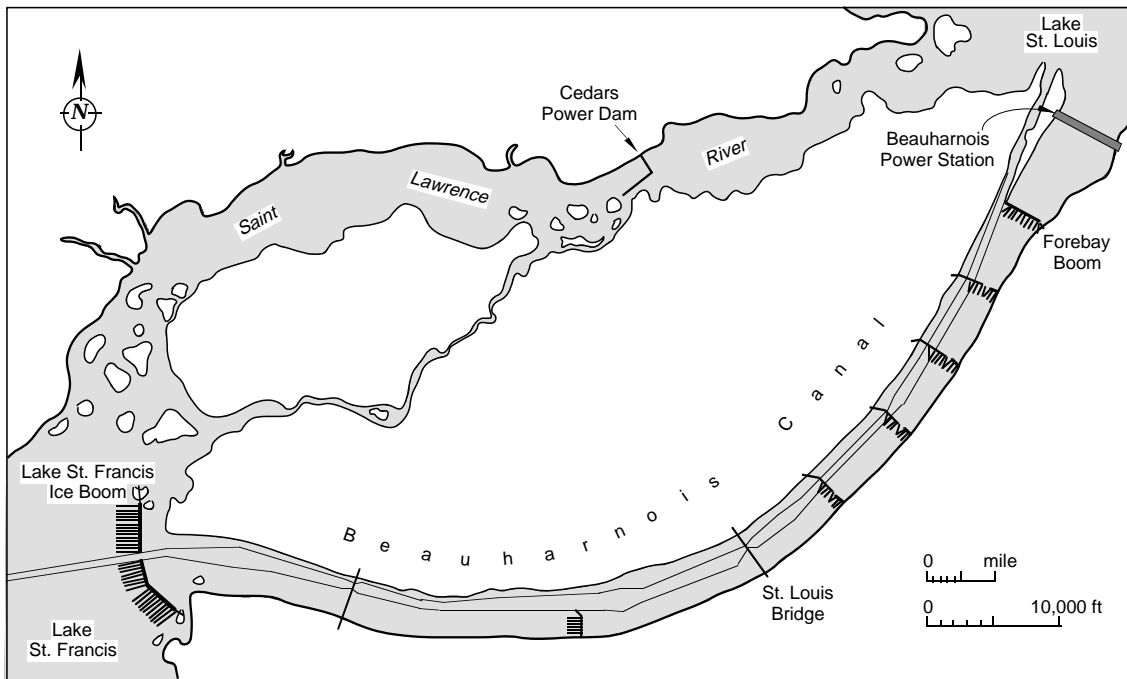

Figure 4. Locations of ice booms on the Beauharnois Canal.

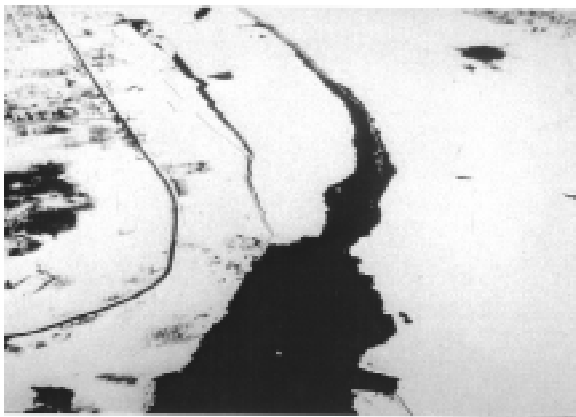

Figure 5. St. Marys River ice boom.

early spring. The 15-mile-long by 3300-ft-wide canal diverts between 140,000 and 260,000 ft<sup>3</sup>/s from the St. Lawrence to the 1600-MW hydro station at Beauharnois (Fig. 4). The 7800-ft-long Lake St. Francis boom has a centrally located navigation opening, allowing for ship passage during the formation and breakup periods. (The St. Lawrence is closed to winter navigation above Montreal.) The opening also allows some frazil to pass downstream during freeze-up, hastening the upstream progression of the ice cover within the canal. The boom units consist of rectangular steel pontoons. A review of the available literature and interviews with operators found no evidence of massive quantities of

wind-driven lake ice overriding the Lake St. Francis boom, as is the case with the Lake Erie boom.\*

A similar but smaller timber boom is located on the St. Marys River, south of the locks at Sault Ste. Marie, Michigan (Fig. 6). Since its first installation in the winter of 1975-76, the boom has performed well, with only minor modifications (Perham 1977, 1978, 1984, 1985). The boom's centrally located navigation opening allows the passage of



Figure 6. Boom on Beauharnois Canal, constructed of double steel pontoons.

downbound vessels while limiting the ice volume entering the constricted channel at the Little Rapids Cut. For the same purpose, a four-span timber boom with a navigation opening was installed in 1976 at the Copeland Cut on the Wiley-Dondero Canal near Massena, New York. The boom performed well during its first season of use (Uzuner et al. 1977), but no recent information on the boom's performance has been obtained.

#### *Ice control for hydropower*

Upstream of Montreal the focus of the ice control efforts shifts from navigation and ice jam prevention to hydroelectric production. The Lake Erie and Lake St. Francis booms could be placed in this group, since they are both located upstream of hydrostations and their failure to perform results in production losses.

Downstream of the Lake St. Francis boom, a series of six steel pontoon booms on the Beauharnois Canal promote the rapid formation of an ice cover, upstream of the power station (Fig. 4).

\* Personal communication with Gilles Maisoneuve, Hydro Quebec, Centrale Beauharnois, April 1994.

Rapid ice cover progression depends on flow reductions during the 7- to 14-day formation period. Since flow reduction is costly in terms of lost hydropower production, the operators closely monitor water temperatures and weather to decide when to form the cover. As with the Lake St. Francis boom, central gaps in the upstream booms allow some frazil and floes to move through to the downstream booms, speeding the upstream progression of the ice cover. The two booms nearest the forebay are constructed of double circular steel pontoons as shown in Figure 6. The four upstream booms within the canal, originally timbers, have been replaced in recent years by rectangular steel pontoons, reducing maintenance costs. Once the ice cover forms in the canal, flow increases smooth the cover's underside, decreasing hydropower head losses. Flow is again decreased for a short period at breakup to reduce the ice forces on the booms. Strain links on three of the anchor lines of the forebay boom provide valuable force data, which guide operators on when to reduce or increase the flow. Ice management at Beauharnois is estimated to increase winter production by an average of 200 MW (Perham and Raciot 1975, Perham 1975\*).

Ice control is equally important to hydro-power production in the International Section of the St. Lawrence. The New York Power Authority and Ontario Hydro annually install six timber booms with a total length of roughly 15,000 ft in the 8-mile-long reach from Galop Island to Ogdensburg (Fig. 7a and b). The booms are part of an extensive ice management program, designed to maximize winter power production at the Moses Saunders Dam at Massena, New York, 40 miles downstream. The booms form an ice cover upstream of Lake St. Lawrence, the dam's pool, reducing the production of frazil. Before the booms were installed in the fall of 1959, severe hanging dams formed at the upstream edge of Lake St. Lawrence, resulting in significant production losses at the hydro stations at Massena. The booms have performed well, with only minor modifications, since their first deployment 34 years ago. Careful flow manipulation at the dam at Massena and the Iroquois control structure (Fig. 7c), airborne surveillance and field measurement of ice thickness and water temperature are all critical components of the overall ice management scheme on

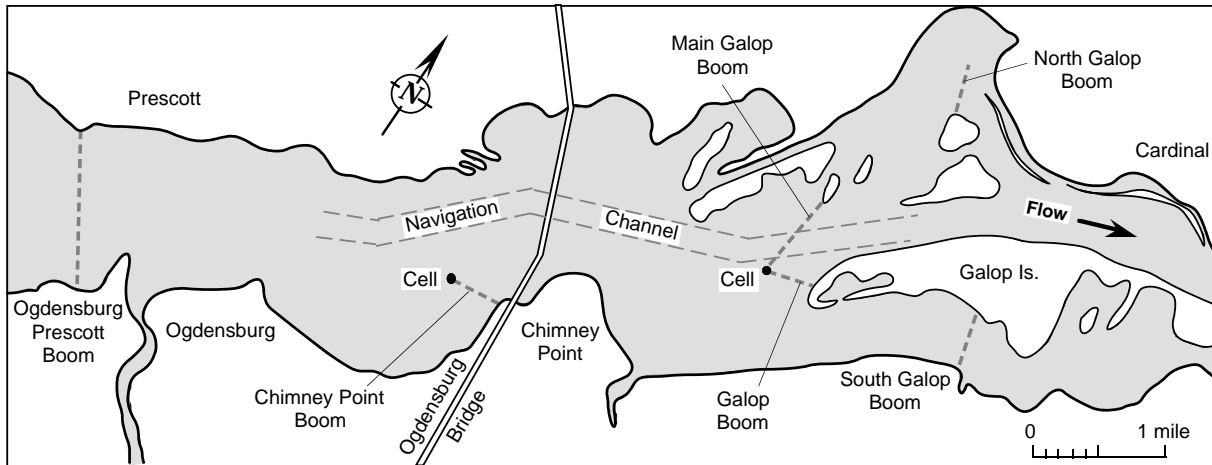

a. Locations of booms.



b. Ice boom at Prescott, Ontario.



c. Iroquois control structure.

Figure 7. Ice booms on the International Section of the St. Lawrence River.

the International Section of the St. Lawrence (Perham 1974, Power Authority of the State of New York 1970, Bryce 1982\*).

More recently, ice booms have been used successfully in northern Quebec during construction phases of the 10,300-MW James Bay Project on the La Grande River. Presently, there are no ice booms in use, however.† On the 5300-MW Churchill Falls Project in Newfoundland, a boom promotes ice cover formation in Jacopie Lake, above the forebay. The boom also helps prevent jams in a channel constriction downstream at breakup (Atkinson and Waters 1978). Ice booms have been used upstream of hydro-power dams in northern Europe, particularly in Norway and Sweden. In the late sixties, a boom

made of double rows of 2-ft-diameter plastic pipe was installed on the Pasvik River, in the forebay area of the Hestefoss power plant on the Russian border with Norway. The plastic booms formed part of an elaborate ice control system involving stone groins and timber booms. The system was designed by Norwegian engineers to promote an ice cover during the plant's construction (Kanavin 1970). The plant is now operated by the Russians and little is known about the recent performance of the booms (Roen and Tesaker 1988).

Ice management on the Lule River in northern Sweden has similarities to methods used on the upper St. Lawrence. Upstream of the Vittarv power station, a 2000-ft-long boom spans the Lule River. Similar to the Beauharnois booms, a 330-ft-wide central section allows floes to pass and contribute to the ice cover progression in a narrow reach downstream. The gap is closed once a cover has formed in the narrow reach. If

\* Also, personal communication with Dan Herrmann of NYPA, April 1994.

† Personal communication with Donald Carter, ice consultant for Hydro Quebec, July 1994.

the concentration of frazil floes is low during the formation period, large sheets of shore ice are broken or sawed free from locations below the boom and allowed to drift downstream to bridge in the channel, promoting arch formation. Like the International Section of the St. Lawrence, booms were installed only after major channel dredging projects failed to promote ice cover growth at all critical locations. Also like the upper St. Lawrence, the ice formation period is carefully coordinated with flow control at hydro stations up and down the river, and a special ice management group oversees the entire operation (Billfalk 1984).

A physical model study by Decsi and Szepessy (1988) aided in the design of an ice boom on the Danube River, upstream of the dam on the Dunakiliti-Hrusov Reservoir, on the Hungary-

Czechoslovakia border. The 3000-ft-long boom stabilizes shore ice and prevents it from entering the forebay area. In conjunction with the effort to stabilize the shore ice, an ice-free main channel is maintained, allowing for conveyance of floes from upstream through the gates on the dam.

Two ice booms were installed on the lower Vistula River in Poland during the winter of 1986 to hasten the formation of a stable ice cover and help prevent hanging dam formation on the upper part of the Wloclawek Reservoir (Grzes 1989). The first boom was located on the reservoir itself, and the second on the free-flowing river upstream of the reservoir. Similar to ice control on the International Section of the St. Lawrence, boom placement was done in conjunction with dredging to reduce the surface water current velocity.

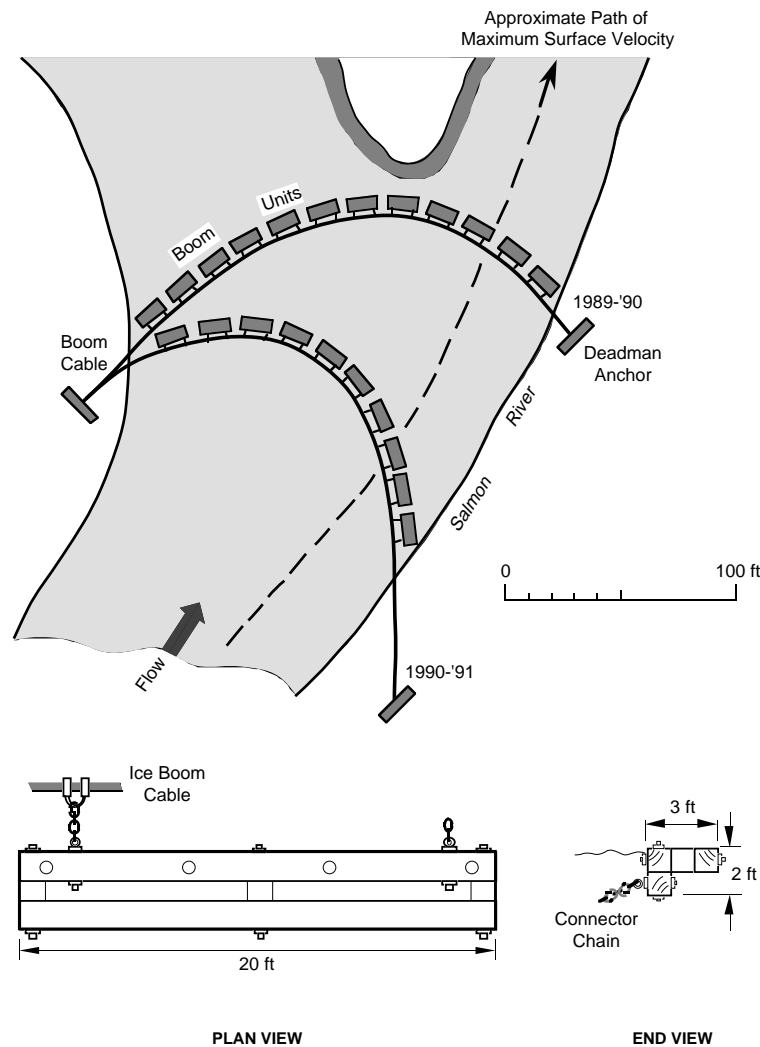

Figure 8. Two boom configurations tested at Salmon, Idaho.

### *Formation booms to prevent ice jam flooding along rivers*

Formation booms have helped solve ice jam problems on pool-riffle rivers. Freeze-up jams occur naturally at slope reduction points, progressing upstream, sometimes flooding towns and property. Thick frazil deposits may also increase the ice volume supplying potential breakup jams, or if the deposits remain in place at breakup, the frazil may stop ice floes from upstream, resulting in a breakup jam. A formation boom may be installed to create an ice cover upstream of the traditional problem area. The ice cover behind the boom reduces local frazil production and captures much of the frazil arriving from upstream.

This was the design intent of the timber boom installed in 1989 on the Salmon River upstream of Salmon, Idaho, a town that had historically experienced a freeze-up ice jam flood one out of every three years. During the Salmon boom's second year of use, in 1990-91, the right bank anchor was relocated 240 ft upstream as shown in Figure 8. The new configuration diverted surface flow and ice away from the zone of highest surface velocity, greatly improving the frazil capture efficiency. Although difficult to quantify because of the short period of record, the Salmon boom appeared to have a positive effect in terms of limiting the progression of potential freeze-up ice jams below the town of Salmon during the winters of 1989-1992. The boom was not installed for the 1992-93 or 1993-94 winters, however (Axelson et al. 1990, White 1992, White and Zufelt 1993).

A well-sited formation boom on the Allegheny River (Fig. 9) significantly reduced the volume of frazil depositing every winter at the mouth of Oil Creek near Oil City, Pennsylvania.

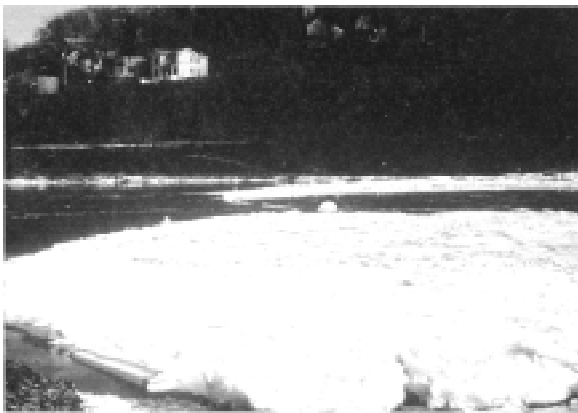

Figure 9. Allegheny River ice boom.

The Allegheny boom, an innovative upstream vee [V] design, pushes flow and ice towards the shores, to capture frazil and form a cover at a location where a traditional single-sag boom had failed. The tip of the vee was connected by cables to anchors on each bank, eliminating the need for a midchannel anchor. Since the hydraulic conditions at the site are marginal, successful ice cover growth behind the boom depends on flow reduction at an upstream dam during the formation period. This boom, in conjunction with a weir structure to trap frazil on Oil Creek, has significantly reduced the occurrence of breakup ice jam flooding in Oil City since its first installation in 1982 (Perham 1983, Deck and Gooch 1984, U.S. Army Corps of Engineers 1985, Gooch and Daly, in prep.).

A pair of 200-ft-wide ice booms was installed in 1968 on the North Platte River, seven miles upstream of Casper, Wyoming, to protect a residential development from freeze-up ice jam flooding. A physical model study by Burgi (1971), of the Bureau of Reclamation, found an upstream vee design optimal, similar to the configuration used over a decade later on the Allegheny River boom at Oil City. However, on the North Platte a single-sag design, rather than the upstream vee, was used, perhaps due to the added complication of placing midchannel anchors in a moveable-bed river. The design was also unique in that the 14-in.  $\times$  20-in.  $\times$  12-ft timbers had steel spikes protruding 6 in. above and below, in an attempt to increase frazil capture efficiency. It appears that the booms are no longer installed, however, since Bureau of Reclamation personnel near Casper know nothing about them.\*

### *Sink-and-float ice booms*

Since the annual installation and removal of ice booms is costly, the Canadian Coast Guard is considering the use of a sink-and-float boom (yet to be developed) on Lake St. Peter. At the end of the ice season the booms would simply be sunk in place for storage during the open-water season. During the late fall the individual pontoons would be raised to the surface, drained and re-floated. An existing structure, similar in concept, protects the harbor entrance at Hokkaido, Japan, from drifting pack ice (Imaizumi et al. 1993). When there is no pack ice present, or during winter vessel transits in and out of the harbor, the pontoons lie on the seabed. The pontoons are re-

\* Personal communication with Phil Burgi, 1994.

floated automatically by the injection of compressed air. Developed by Nishimura-Gumi Co. LTD, the pontoons have a teardrop cross-sectional shape, minimizing the tendency for burial by deposition of sediment while resting on the bed.

### *Groins*

With the exception of artificial islands, the Montreal Harbor ICS and the Japanese sink-and-float booms, all structures described up to this point have been floating, flexible, seasonally deployed and relatively inexpensive. None of the structures described so far cause a significant water level change in the absence of ice or act as a barrier to migrating fish. Aside from midchannel anchors for multiple-span booms, ice booms have little negative effect on the riverbed. Much of this is in contrast to the next group of fixed-sheet ice retention structures, which includes groins, weirs and dams.

As mentioned earlier, the majority of sheet ice retention methods are successful only under the hydraulic conditions of relatively low energy slope, low water surface velocity and low Froude number. By raising the upstream water level, groins, weirs and dams may create conditions favorable for the formation of a sheet ice cover. In addition, structurally raising the water level and reducing the surface water velocity may make the capture of ice behind a boom possible where it was not before.

Stone groins, or jetties, extending perpendicularly into the channel from the shoreline, stabilize the shore ice and may, under the appropriate hydraulic conditions, encourage bridging and ice cover formation across the channel. The tops of these structures are typically above the water level during the freeze-up period. As an added benefit, the groins raise the upstream water level, creating hydraulic conditions more favorable for ice cover formation, with or without the use of ice booms. Groins, since they do not cross the entire channel width, have an environmental advantage over weirs and dams since they do not totally obstruct navigation or migrating fish.

A system of groins, used in conjunction with booms, promotes ice cover formation upstream of the hydrostation at Hestefoss in northern Norway (Kanavin 1970, Perham 1983, U.S. Army Corps of Engineers 1985). On the Burntwood River of the Churchill River Diversion Project, Manitoba Hydro uses two opposing groins, or wing dikes, to raise the upstream water level

and promote ice cover formation (Perham 1983, U.S. Army Corps of Engineers 1985). Updated information on the performance of these structures is not available. Burgi modeled opposing groins as a means of enhancing boom performance on the North Platte, upstream of Casper, Wyoming (Burgi 1971). The groins were not built, however.

Submerged weirs are being constructed along the outside of bends on the Mississippi to direct flow towards the dredged navigation channel. These structures, known as bendway weirs, are mentioned in this report since they are likely to improve ice conveyance. Engineers in the St. Louis District of the U.S. Army Corps of Engineers would like to locate a series of bendway weirs at the Mississippi–Missouri River confluence (*Civil Engineering* 1994). If constructed, the effect of this channel modification on the local ice regime will be observed closely since this location is a well-known ice jam problem site. Bendway weirs may prove to be an effective ice control tool in the future.

### *Dams and fixed weirs*

Although seldom constructed solely for ice control, the most effective ice control structure is a dam or weir. By raising the water level and reducing the water current velocity, these structures may allow the thermal growth of an ice sheet or serve as a barrier for the juxtaposition of frazil or frazil pans. The pool behind a dam or weir stores frazil transported from open reaches above, preventing its transport to a potential freeze-up jam site below. A later section of this report describes how weirs with piers reduce the severity of breakup ice jams by retaining a stable ice accumulation, thus limiting the ice supply to potential downstream jams.

Sartigan Dam, upstream of St. Georges, Quebec, with a drop of 40 ft, creates a 2.5-mile-long pool on the Chaudiere River (Fig. 10). The dam was designed and built in 1967 for the sole purpose of ice control (Michel 1971). Much of the frazil that once contributed to the severe jams at St. Georges is now stored beneath the pool's ice cover. Small stone weirs, some experimental, have been used to form pools and trap frazil on other rivers in Quebec, Ontario and northern New England (Perham 1983, U.S. Army Corps of Engineers 1985, Cumming–Cockburn and Associates Ltd. 1986a).

A 6-ft-high, concrete-capped, rock-filled gabion weir with sluiceway slots on the Israel River has



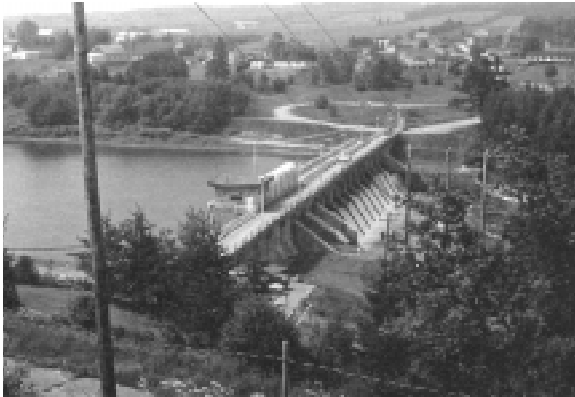

a. Downstream side.



b. Upstream side, showing the ice retention grates.

Figure 10. Ice control dam on the Chaudiere River at St. Georges, Quebec.



Figure 11. Ice control weir on the Israel River, Lancaster, New Hampshire, July 1994.

provided the town of Lancaster, New Hampshire, some ice jam relief by reducing the frazil quantities historically deposited downstream of town. Although designed to retain frazil, the weir to some degree acts as a barrier to breakup ice, as shown in Figure 11 (Perham 1983, Axelsson 1991). A site visit in July 1994 found the weir

in relatively good repair. The weir has experienced minor settlement, and gravel deposits upstream are beginning to limit the pool depth. At present the New England Division of the Corps of Engineers would like to transfer ownership of the structure to the town. Since the town is not interested, the structure will most likely be removed in the near future.\*

The 306-ft-wide gated concrete weir, shown in Figure 12, creates a 5-ft-deep pool to trap frazil on Oil Creek in Pennsylvania. The weir is part of the solution to Oil Creek's historically severe ice jam problem. Initially a boom was seasonally



Figure 12. Ice control weir on Oil Creek, upstream of Oil City, Pennsylvania.

installed upstream of the weir until it was found that an ice cover formed behind the weir without the boom in place. Although not the original design intent, the Oil City weir affords some degree of breakup protection by delaying movement of the upstream ice until the downstream ice has had a chance to clear out (Gooch, in prep., Gooch and Daly, in prep.).

As an example of the effectiveness of a system of dams in ice control, the upper Mississippi above St. Louis contributes little or no ice to the severe ice jam problems in the undammed middle Mississippi, between St. Louis and Cairo, Illinois. Most of the problem ice originates in the Missouri River, undammed for 800 miles above its confluence with the Mississippi, or from ice generated in middle Mississippi itself. In addition, many of the ice control measures, existing or proposed, are in response to the removal or decay of existing dams across the northern

\* Personal communication with Scott Acone, New England Division of the Corps of Engineers.

United States and southern Canada. There has been a marked increase in ice jam flood frequency on smaller rivers as small mill dams fall into disrepair and are removed.

*Removable weirs*

Experimental tension weirs placed in small rivers have successfully created pools and ice covers for the purpose of limiting frazil production. Researchers at CRREL initially used a structure consisting of vertical wood 2 × 4s attached to top and bottom cables, referred to as a fence boom (Fig. 13) (Perham 1986). The intent was for frazil to accumulate in the gaps, creating an ice dam and an impoundment. Field tests were relatively successful but scour was a problem in unarmored riverbeds. Other materials such as chain link fence were tried with relative success (Foltyn 1990).

Mineta et al. (1994) reported the successful



*a. Installed condition.*



*b. After ice cover formation.*

**Figure 13.** Fence boom installed on the Mascoma River, Lebanon, New Hampshire.

deployment of a freestanding fence boom or “ice fence” on the Penkeniuppi River on the Japanese island of Hokkaido. Inspired by Perham’s fence boom, this structure is made up of 3-ft-wide individual steel frames supporting 3.3-ft-long, 2- × 2-in. wood pieces, inclined away from the flow at 60°. The gap width is 2.8 in. and the frames are connected by steel pipe. Figure 14 shows the units spanning a 90-ft-wide riffle section of river 1000 ft upstream of a small power dam. Since installed in 1991, the ice fence has eliminated the previously frequent interruptions to power production resulting from frazil accumulations at the intakes. The frazil accumulation that forms behind the structure at the channel center diverts water flow towards the banks, where velocities reach 3.5 ft/s, resulting in some bed scour. To reduce the scour, the banks are armored with stone-filled gabions. The structure was developed through a cooperative effort between engi-

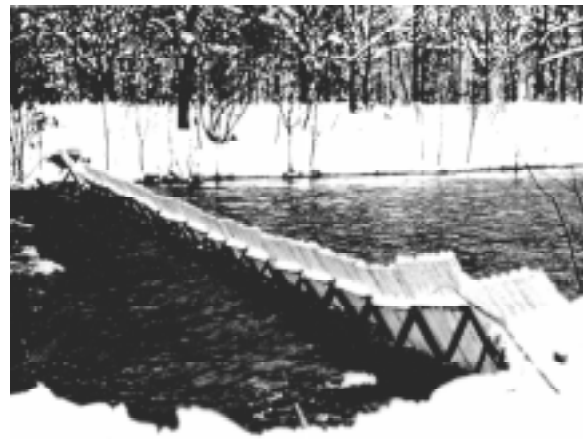

*a. Installed condition of the ice fence, 24 December 1991.*



*b. Ice cover formed behind the ice fence, 23 January 1992.*

**Figure 14.** Ice fence on the Penkeniuppi River in northern Japan. (Photos courtesy of Ken-ichi Hirayama and the Hokkaido Electric Co.)

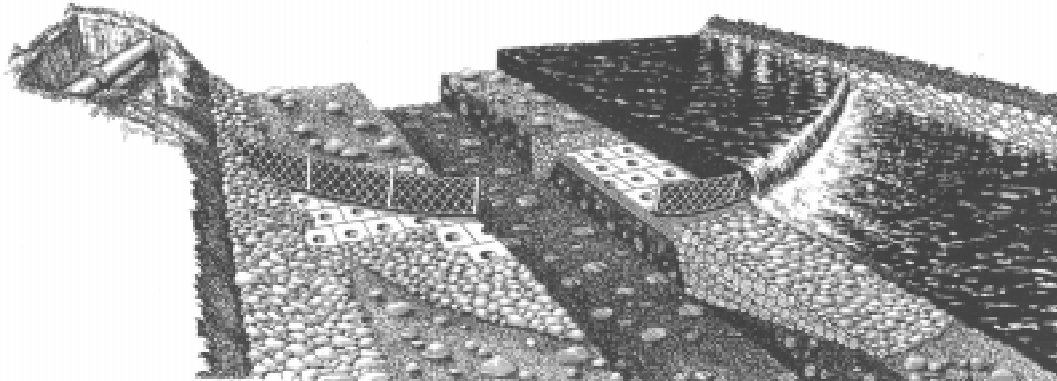

a. Schematic showing the wier, anchors and bed protectors.



b. Ice cover formed behind the wier

Figure 15. Tension weir on the Ompompanoosuc River at Union Village, Vermont.

neers at Iwate University and the Hokkaido Electric Power Co.

The winters of 1993 and 1994 saw successful field demonstrations of an impermeable tension weir at a site on the Ompompanoosuc River in Union Village, Vermont. The 60-ft-wide structure, consisting of vertical steel posts, a wire rope mesh and a rubber-like fabric, created a 3-ft-deep pool, initiating the formation of a smooth sheet ice cover (Fig. 15). Concrete and riprap bed protection prevented all but minor scour. The Union Village structure fulfilled its design objectives of low cost, easy installation and applicability to small, unnavigable rivers. The issue of scaling removable weir technology up to larger rivers is worth examining, since these structures do not interfere with open water season uses of the river such as navigation and recreation.

#### *Frazil collector lines and ice nets*

Tests of ice cover formation using arrays of ropes, or frazil collector lines, by Perham (1981, 1983) were relatively successful (Fig. 16). Tang-

ling of the lines in turbulent water was a problem, however. In addition, should the lines be carried away at breakup, they might present a nuisance or hazard at downstream locations. Sahlberg (1990) described a similar method—ice nets—to capture frazil and cause an ice cover to

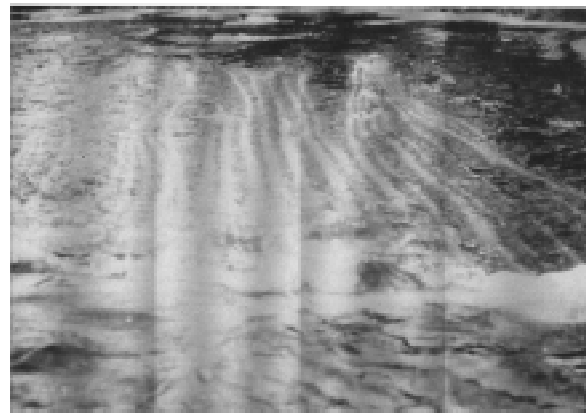

Figure 16. Frazil collector lines being tested on the Mascoma River, 1981. The view is looking upstream. Frazil accumulates on the individual lines, which are floating near the surface.

form. Ice nets were successfully deployed in the winter of 1989-90 in front of the intakes at the Stornorrfors hydrostation on the Ume River in Sweden. In their few applications to date, frazil nets and lines have promoted ice cover growth in channels with surface velocities as great as 3 ft/s, compared to 2.5 ft/s, the upper velocity limit for other sheet ice retention structures.

## **BREAKUP ICE CONTROL STRUCTURES**

Many of the previous examples illustrate the difficulty in categorizing sheet ice retention structures separately from structures to control breakup ice, since many perform both roles. The next section will describe structures whose main function is breakup ice control.

The technology for breakup ice control is less developed and less well documented than sheet ice retention technology. In many ways, the problem is more complex. A breakup ice control structure may be designed to cause an ice jam at a desired location. Forces on a breakup ice control structure are typically much greater than on a sheet ice retention structure. On steep rivers with dynamic breakups, forces on the ice accumulation may be sufficient to cause internal failure and thickening of the ice accumulation by shoving, rather than by juxtaposition, as with sheet ice retention. Forces resulting from momentum transfer, both from within the ice accumulation and from direct impact of ice pieces on the structure, are much greater than in the sheet ice retention case. A breakup ice control structure may cause the ice to thicken to the point where flow is impinged along the bed or banks, resulting in scour. For this reason, a significant part of the cost of the structure may lie in bed and bank protection. Discharges associated with breakup often reach flood levels, in contrast with the base flow levels commonly associated with the freeze-up period. The design of a breakup structure must address the issues of ice supply, ice storage, flow relief and ice accumulation stability. If the breakup and annual peak flows coincide, as is often the case, the breakup structure must be designed to retain the upstream ice while passing the flood flow. This may be achieved either by storing ice behind a grounded jam in the main channel while bypassing the flow in the overbank, or by storing the bulk of the ice in the floodplain areas while routing the flow under a stable, floating ice accumulation in the main channel. For the grounded jam with bypass flow

in the floodplain, erosion protection must be provided, particularly where the flow exits from and returns to the main channel. A weir is usually needed if relief flow is to pass under a stable floating ice accumulation in the main channel, since design velocities must be low enough, and the depth of flow great enough, to avoid excessive thickening. These issues are further illustrated in the following sections on breakup ice control structure purposes, types and examples.

### **Purpose**

The purpose of a breakup ice control structure may be simply to retain the breakup ice run at an undeveloped location upstream of the historic ice jam problem site, reducing the flood threat to settled areas. River towns at transition points from steep to mild slope pose a particularly severe ice jam problem, since their location not only favors the deposition of frazil but provides a likely stopping place for the breakup ice run. These changes in slope often coincide with river confluences. As mentioned in the previous section, many breakup structures such as weirs have the dual purposes of creating an impoundment to capture and store frazil during the course of the winter, as well as retaining the breakup ice run.

### **Types**

Wire rope breakup structures have been used on small rivers in New England with limited success. If the intent is to create a grounded jam, a breakup ice control structure may be as simple as a line of boulders or piers, spaced at intervals across a river channel. Weir structures and weirs with piers have successfully retained floating ice accumulations, reducing ice jam severity at downstream locations. In addition to their value in trapping and storing frazil, large dams are extremely effective barriers for breaking up ice runs. Some unique structures prevent breakup ice from passing dam spillways. Finally, structures designed to withstand the forces generated by pack ice off the northern coast of Japan might be applied to breakup ice problems on major U.S. rivers.

### **Examples**

#### *Wire rope structures*

A military surplus submarine net was installed on the Israel River 1 mile upstream of Lancaster, New Hampshire, in the early seventies to retain breakup ice. According to field observers, during ice runs the structure fills with ice pieces to act as



Figure 17. Credit River ice control structure following breakup, March 1994. Note the ice stored on the right flood plain. (Photos courtesy of Harold Belore.)

a weir, with water flow and ice passing over its top. The submarine net requires some maintenance, mainly in the form of debris removal.

Perham (1983) reported the use of an experimental breakup boom on the Chaudiere River in Quebec in the sixties. Available descriptions are sketchy. Apparently the boom resembled a horizontal rope ladder constructed of two 1-in. cables and structural steel rungs. The spaces between the rungs were filled with wooden blocks. Attached to heavy concrete shore anchors, the boom was expected to retain breakup up to a discharge of 7200 cfs (the four-year flood). The boom was used in conjunction with a stone weir, which was located a short distance downstream.

At Hardwick, Vermont, two booms constructed of used ski lift cables and truck tires are installed on the Lamoille River each winter. In order for the tires to stand vertically, the cables are relatively taut, even in the no-load condition. Due to this no-sag design, cable forces during the ice run are high enough to cause failure. Nevertheless, by temporarily retaining upstream ice, the tire booms appear to stagger the arrival of ice and water surges in the thickly settled reach downstream, reducing the chance of a serious ice jam.

#### *Piers and boulders*

A pier structure on the Credit River has protected property downstream in Mississauga, Ontario, since its construction in 1988 (Fig. 17). The ice control structure consists of 14 concrete piers on 6.6-ft centers. The tops of the piers are roughly 1.5 ft above the 1.5-year open water flood level. A grounded jam forms behind the piers, with the top of the ice rubble 3 ft above the top of the pier height. The resulting impound-



Figure 18. Cut granite block ice control structure in Hardwick, Vermont, following breakup, March 1995.

ment is designed to store 95,000 cubic yards of ice, two thirds on the right floodplain and the remaining third in the channel. Relief flow passes around the structure on the right floodplain, which is spanned by two rows of armor stone, also with 6.6-ft gaps. To encourage relief flow to enter the floodplain, the tops of the armor stone are 1.5 ft lower than the tops of the piers in the main structure. Aside from some scour, occurring where relief flow from the floodplain re-enters the main channel, and ongoing debris removal, the structure has performed well to date (Cumming-Cockburn and Associates Ltd. 1986b)\*.

A granite-block breakup ice control structure, shown in Figure 18, was constructed in the Lamoille River, upstream of Hardwick, Vermont, in September 1994. The four blocks are located at the downstream end of a natural pool, with a

\* Also, personal communication with Harold Belore, May 1994.

gap width of 14 ft. Two smaller blocks bolted to the sides of each of the main blocks increase stability, bringing the total weight to 40 tons. The upstream faces of the blocks are sloped at 45°. The block tops are roughly 1 ft above the elevation of the right floodplain, which passes the relief flow but is not intended as an ice storage area. A major portion of the structure's cost lies in riprap for bed and bank protection in the vicinity of the blocks, and also along the banks where the relief flow leaves and re-enters the main channel. The design process included a physical model study in the refrigerated research area in the Ice Engineering Facility at CRREL (Lever 1995). The prototype performed well during its first winter (1994-95), retaining breakup ice runs in early January and mid-March.

Three poured concrete "icebreaker" blocks were installed in the Mohawk River, one mile above the village of Colebrook, New Hampshire, some 50 years ago. The bed slope at the blocks' location is relatively steep, and the blocks do not stop the breakup ice run. After consulting with researchers from CRREL, the New England Division of the Corps of Engineers in the early sixties planned to create an ice storage reservoir to alleviate the ice jam flooding at Colebrook (Assur and Frankenstein 1963). The proposed timber crib structure, with a centrally located concrete spillway, was never built, however.

Two pier structures in Hungary protect the villages of Jaklovce and Zilnia from ice jam flooding (Brachtl 1974). Both structures consist of 8-in.-diameter concrete-filled steel piles, on

6.6-ft centers, inclined in the downstream direction. The tops of the piles are roughly level with the floodplain elevation. The structures are designed to convey a flood discharge with the entire structure clogged with ice or debris. Installed around 1970 to solve ice jam flood problems created by reservoir construction, little is known about their performance since 1974. The Hungarian structures are similar to the structure on the Credit River. Both use piers, spaced at 6.6 ft, to create grounded jams, forcing relief flow and ice onto the floodplain.

#### *Weirs with piers*

A 15-ft-high by 260-ft-wide concrete weir topped with 6-ft-high piers on the Ste. Anne River protects the town of St. Raymond, Quebec, from breakup ice jam flooding (Fig. 19) (Deck 1984). The piers are spaced roughly 20 ft apart. An earth berm connects the structure's left end to the higher ground to the left of a 500-ft-wide floodplain. The structure creates an ice storage reservoir 700-ft-wide by several thousand feet long, passing the relief flow beneath the ice accumulation in the main channel and directly over the weir. The design must ensure a pool level high enough to reduce the approach velocity and water surface slope so that excessive thickening does not result in a grounded jam at the structure. If the weir failed to pass the breakup flood flow and the berm on the left were overtopped, a small housing development would be flooded. This consideration indicates a high level of confidence in the design. Six-tenths of a mile downstream, the town of St. Raymond lies on a flat valley bottom, below a relatively



Figure 19. Weir with piers ice control structure on the Ste. Anne River, St. Raymond, Quebec. (Photo courtesy of Marc Delagrave, Roch Itée Groupe-conseil, Sainte-Foy, Quebec.)

steeper section of the Ste. Anne River. The structure has dual roles. The 15-ft-deep pool behind the weir stores frazil, preventing its deposition in St. Raymond, as well as protecting the town from breakup ice jam flooding.

Information on the design approach and performance of the St. Raymond structure was difficult to find. Albert Real Tremble of the Quebec Ministry of Environment and Forests was involved with the St. Raymond structure and similar ice control projects in Quebec. The design process was somewhat empirical, relying on the successful experience with the ice control dam at St. Georges.\* During breakup, a floating accumulation of broken ice pieces, and not sheet ice, arches between the piers.† Jean-Phillippe Saucet of LaSalle Consulting Group Inc. is working on the design of a similar breakup structure for the Becancour River, near Trois Rivieres, Quebec. The key is to design a weir that will create upstream hydraulic conditions that allow the formation of a stable floating equilibrium ice accumulation, for the expected range of breakup discharges.\*\* The plans for the Becancour structure show a 140-ft-wide weir with piers spaced at 20 ft and a gated bottom outlet.

#### *Breakup ice retention at dam spillways*

The Sartigan Dam at St. Georges, Quebec, (Fig. 10) is mentioned again in this section due to its role as a breakup ice control structure (Michel 1971, Perham 1983). The dam is a larger version of the Ste. Anne River weir-with-piers structure at St. Raymond, with eleven 20-ft-wide overflow gates, separated by concrete piers. The gates are equipped with steel grates with 2.0-ft-wide by 3.5-ft-high openings to retain breakup ice. Residents of St. Georges interviewed in 1994 believed that the dam has solved the town's historic ice jam flood problem.

A 7-ft-high timber crib dam, designed by the Corps of Engineers, was constructed on the Narragausus River in 1961 to protect the town of Cherryfield, Maine, (roughly 1 mile downstream) from breakup ice jams (Fig. 21) (Perham 1983). Upstream of the dam are three rock-filled timber cribs on 50-ft centers, designed to prevent large pieces of sheet ice from passing the dam's 140-ft-wide central spillway. The dam creates an ice storage reservoir and is similar to the proposed ice control project for the Mohawk River at Colebrook, N.H. During an intense rainfall event in February 1968, the sheet ice behind the dam re-

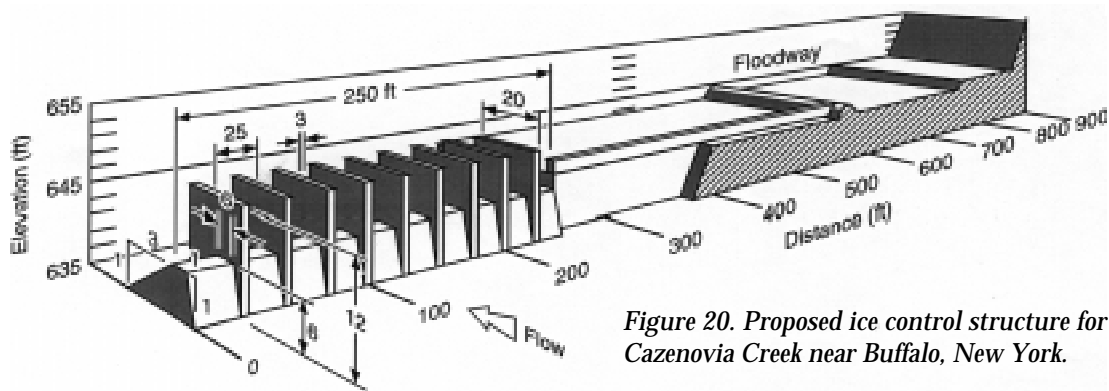

*Figure 20. Proposed ice control structure for Cazenovia Creek near Buffalo, New York.*

The St. Raymond structure influenced the design of a similar breakup ice control structure for Cazenovia Creek near Buffalo, N.Y. (Gooch and Deck 1990). Although a promising design was developed (Fig. 20) through a physical model study at CRREL, lack of funding prevented construction of the prototype.



*Figure 21. Rock-filled timber cribs upstream of the dam at Cherryfield, Maine.*

\* Personal communication with Albert Real Tremble, September 1994.

† Personal communication with Marc Delgrave of Roche Itec Consultants, September 1994.

\*\* Personal communication with Jean-Phillippe Saucet of LaSalle Consulting Group Inc., September 1994.

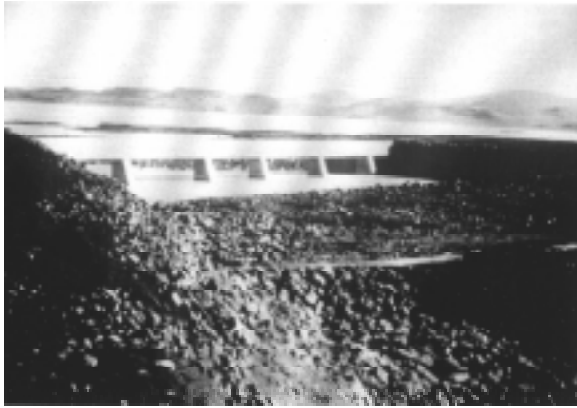

Figure 22. Spillway barrier at the outlet of the Sigalda Reservoir in Iceland.

mained intact. There was sufficient ice downstream of the dam to supply a jam in Cherryfield, however. This experience and others show that an effective breakup ice control structure needs to be quite close to the site being protected. Although there have been frequent jams in Cherryfield since 1968, there have been no incidents of ice jam flooding, suggesting that the dam continues to have a positive effect.\*

A fixed concrete spillway barrier at the outlet of the Sigalda Reservoir in Iceland was designed to prevent ice floes from entering the Tungnaa River and damaging the hydroelectric installations downstream during low-frequency, high-discharge events (Fig. 22) (Perham 1983, U.S. Army Corps of Engineers 1985). No extreme runoff events have occurred to test the structure's effectiveness since its construction in 1977.†

A timber boom in conjunction with a warm-water pumping system prevents large ice floes from passing the spillway at Dickenson Dam on the Heart River in North Dakota. The boom was installed in 1984 after a large floe damaged the crest gate during breakup. The boom has performed well, requiring only minor maintenance.\*\* The design is unique in that the main cable is guyed out at two points to counterweights, to conform to the spillway layout (Burgi and Krogstad 1986).

\* Personal communication with Mona West, Cherryfield town office, September 1994.

† Personal communication with Sigmundur Freysteinnsson, VST Ltd., Reykjavik, Iceland, May 1994.

\*\* Personal communication with Duane Krogstad, Bismark Office of Reclamation.

### Pack ice barriers

Yamaguchi et al. (1981) developed a removable pack ice barrier, constructed of ballasted 22-in.-diameter steel pipe. The structures, shown in Figure 23, are 19 ft high and 33 ft long. Placed in rows, the barriers have protected shorelines and shoreline structures from damage by 1.3- to 1.6-ft-thick wind- and wave-driven pack ice in the Sea of Okhotsk. In rock bed situations, no foundations are needed. Water can flow freely through the structures' legs, so the effect on marine life is minimal. Saeki (1992) reported the successful performance of the pack ice barrier and described similar structures. Although this is a marine application, structures of this type could be adapted to retain breakup ice on major U.S. rivers. Problems of water level fluctuation and foundations in soft sediment or movable-bed rivers would have to be overcome, however.

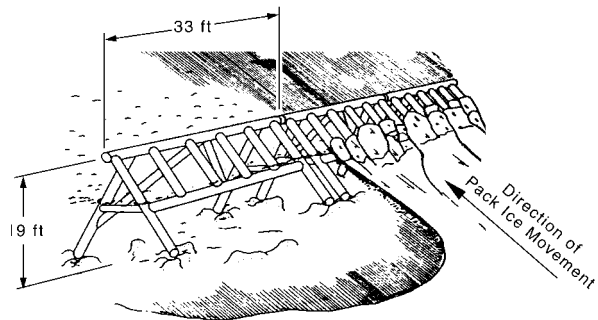

Figure 23. Pack ice barrier, Saroma Lagoon, Sea of Okhotsk. Constructed of 22-in.-diameter steel pipe, the individual units are 19 ft high and 30 ft wide. The direction of ice movement is from lower right to upper left. (After Yamaguchi et al. 1988.)

### ICE DIVERSION STRUCTURES

This final group contains ice control structures whose main purpose is ice diversion. The goal of this type of ice control is often to prevent ice from entering and blocking hydropower intakes. To this end, special structures such as shear booms may be used to direct ice past the forebay area while diverting the water flow from beneath the ice. In the absence of hydropower, an ice diversion structure may guide frazil and floes away from lock entrances or toward gates capable of flushing ice past dams. Ice control at hydropower intakes is well developed in northern Europe and Iceland. This report only touches on the subject since it is relatively unrelated to confluence ice situations. However, preventing



ice from entering locks and flushing ice past dams is a major issue on waterways that carry winter navigation in the U.S.

### Ice diversion at hydropower intakes in northern Europe

At the Burfell power plant in Iceland the discharge of frazil and solid ice may be as great as 55% of the total winter ice and water flow of 3500 cfs. In addition, the river carries a significant sand bedload. The three-level intake structure, shown in Figure 24, consists of an upper-

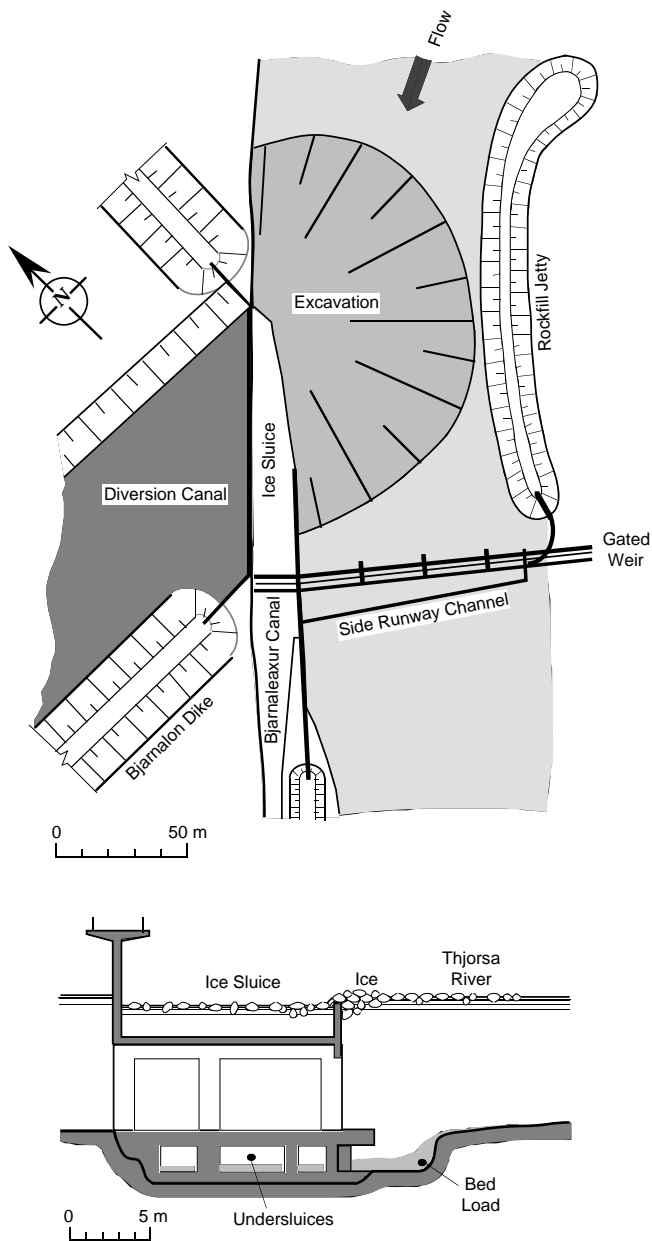

Figure 24. Ice sluice at the intake to the Burfell Power Station, Iceland. (After Carstens 1992.)

level ice sluice and an under sluice for sand, allowing relatively ice- and sediment-free flow to enter the diversion canal leading to the intakes. In addition, a rock-filled jetty and an excavated basin in front of the ice sluice further reduce the ice quantities entering the diversion canal (Carstens 1992).

Perham (1983) described a fixed concrete shear boom at the head of the intake canal to the Hraunjafoss power plant, located downstream of the Sigalda Reservoir in Iceland. Constructed in 1981, the boom extends to a depth of 13 ft and prevents frazil from entering the power canal. The frazil is not sluiced over the adjacent spillway but kept in the reservoir to promote ice cover formation.\* The boom does not provide a complete solution, however, since the surface velocity in the 3300-ft-long canal is too great for an ice cover to form. As a result, frazil accumulates at the trash racks located at the canal's downstream end (Freysteinnsson and Benediktsson 1994).

At the power dam at Rygene, Norway, a 5- × 26-ft ice flushing gate, located 40 ft upstream of the intakes, performed poorly, until a redesign located a new ice sluice gate immediately adjacent to a submerged intake. The ice-flushing capacity was also increased at the power plant at Fiskumfoss, Norway, again by locating a new ice-flushing gate as close to the intakes as possible. At the Burfell, Rygene and Fiskumfoss power stations, physical model studies helped optimize the design of the ice diversion structures upstream of the intakes (Carstens 1992).

In contrast, the intake on the Orkla River, at Bjorset, Norway, has performed poorly, experiencing severe frazil problems. Flow is diverted beneath a shear wall, upstream of a control weir, to enter a 7-mile-long rock tunnel. Frazil accumulates on the trash racks, tunnel walls and even at the downstream surge tank.† The intake's poor performance may result in part from its location 500 ft upstream of the control weir.

### Floating shear booms upstream of dams

Many shear booms designed to divert debris to collection sites along the shore upstream of dams are also effective for ice. In addition, any structure designed to capture or divert debris in cold regions must consider ice forces in the design. The shear boom upstream of the Chief Joseph Dam, a large-scale structure of this type,

\* Personal communication with S. Freysteinnsson, May 1994.

† Site visit, August 1994.



Figure 25. Chief Joseph shear boom on the Columbia River at Bridgeport, Washington.

successfully diverts debris and ice from the fore-bay area (Fig. 25). Located on the Columbia River at Bridgeport, Washington, this 3000-ft-long boom consists of 228 government-surplus mooring floats, 6 ft in diameter by 12 ft long. Each float contains 2.5 tons of concrete ballast. Perham (1983) and Appendix B of the Ice Engineering Manual (U.S. Army Corps of Engineers 1985) give examples of cross-sectional geometry of various types of shear booms. The estimated maximum design load of 103 tons on the 2.5-in.-diameter main cable on the Chief Joseph boom is expected to result from wind and wave loading.

#### Ice diversion at locks

Ice entering locks is a major winter navigation problem on U.S. waterways. Ice in miter gate recesses interferes with their operation, and in severe ice conditions, multiple ice lockages may be required for the passage of a single tow. Bubbler systems and air curtains have been extremely successful on the Illinois Waterway at Starved Rock Lock and Dam. The technology of high-flow air systems is well documented and beyond the scope of this report (U.S. Army Corps of Engineers 1985).

In Sweden, four locks connect the upstream end of the Trollhätte Canal to Lake Vanern, where an ice escape tunnel connects the highest lock to the canal below. Vessels descending through the system tend to push brash ice from the lake into the locks. To counter this, the upper lock is allowed to fill with ice, and the ice is then flushed out en masse through the tunnel. Blasting is sometimes required, however, to clear ice blockages at the tunnel entrance (Solve 1986).

Ice diversion near hydropower intakes is similar to ice control at locks, in that ice flushing

gates or ice spillways tend to work best when located as close as possible to the lock entrance. The Marseilles Lock, on the Illinois Waterway, located at the end of a canal three miles downstream of the Marseilles Dam, presents particularly difficult ice problems. During severe ice conditions as many as four ice lockages are required per tow passage. Perham (1988) described a method using a string of barges to shear ice away from lock entrances (Fig. 26). A tow boat would then move the barges into the open position, allowing traffic to enter or exit the lock. The method is commonly used at locks on the upper Mississippi River.\*

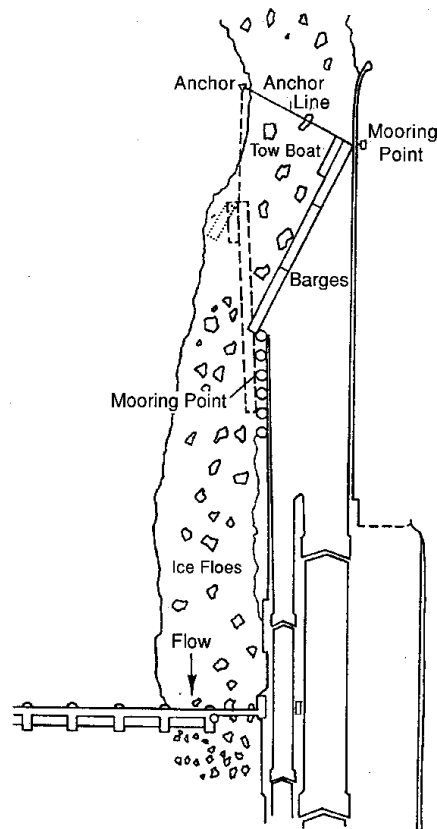

Figure 26. Barges used to shear ice away from a lock entrance. (From Perham 1988.)

#### ANALYSIS AND CONCLUSIONS

This review of existing structures summarizes the information gained in the first part of the work unit on structural ice control methods, conducted under the River Confluence Ice Pro-

\* Personal communication with Edward H. Leuch, U.S. Army Corps of Engineers, Rock Island District, March 1995.

gram. The review brings together information on a wide range of ice control structures, assessing their performance. General conclusions are presented on the current state of development in the field of structural ice control. The next section examines how well existing methods (as well as relatively untried ones) apply to a range of confluence ice situations. Finally, a range of existing ice control structures will be examined with respect to channel depth and average velocity.

### **General conclusions**

Structural methods to help form and retain sheet ice are well developed and relatively well understood. Floating booms, the most common structure type in this group, do not significantly alter the existing hydraulic conditions, and their environmental impact is minimal. Their initial capital cost is low, and applications are possible in very deep channels. A floating boom solution applies to a relatively narrow range of hydraulic conditions, however, and reliability can be limited, as seen in the ice runs that override the Lake Erie boom. The selection of ice boom design to date has been based on a combination of theory, experience, physical model studies and availability and cost of construction materials. The relationship between a boom unit's cross-sectional geometry and its capture efficiency is not that well understood, however. Recent applications of note are the formation booms installed on the Salmon River in Idaho and the Allegheny River at Oil City, Pennsylvania. In both cases the booms caused ice covers to form at locations where the hydraulic conditions were previously thought to be unfavorable. The future may see reduced installation and removal costs through the further development of sink-and-float booms. Efforts are now underway to increase ice boom capture efficiency. These designs might lead to successful ice retention at surface velocities well above the currently accepted maximum of 2.3 ft/s. Finally, floating boom technology might be further developed for the purpose of breakup ice control.

Compared to sheet ice retention, breakup ice control methods are less developed and less well understood. Dams and fixed weirs are effective and time-tested breakup ice control methods, and the ice-hydraulic design aspects involved are fairly straightforward. The object is to create upstream hydraulic conditions of sufficiently low slope and low surface velocity to allow the

formation of a stable, floating ice accumulation, with relief flow passing underneath the ice and over the weir crest. Properly designed, weirs and dams retain breakup ice runs with great reliability. As an added benefit, dams may serve as freeze-up ice control structures by promoting ice cover formation early in the season, thereby reducing frazil production. Major drawbacks are their high capital cost, the obstacles presented to navigation and fish migration, and upstream sedimentation. An example of a successful ice control weir is the structure on the Ste. Anne River in St. Raymond, Quebec. As a further drawback, permitting for new dam construction at present is difficult in the U.S. There may be some potential for ice control using inflatable dams, however.

The greatest development potential in the field of breakup ice control lies in pier structures. A grounded jam forming behind the piers creates an impoundment, allowing the formation of a stable floating ice accumulation upstream. Relief flow is typically routed around the grounded portion of the jam via some type of channel in the overbank area. In the non-ice-jam case, these structures do not cause a rise in water level, so they do not create a barrier to migrating fish or cause upstream sedimentation. Their capital cost is lower than for an equivalent weir structure. Being relatively new technology, the ice and hydraulic design aspects are tricky and not that well understood, so their reliability may be less than for a weir. Scour and debris clogging are also potential problems. A successful example is the pier structure built on the Credit River at Mississauga, Ontario. Future directions might be to scale the current small river applications up to larger rivers or to develop removable frames or collapsible piers that do not interfere with navigation. Application of pier ice control structures to moveable-bed rivers also presents a major challenge.

Recent innovations in freeze-up ice control include the development of fence booms, tension weirs and ice nets. Though limited in their range of application, these methods are extremely inexpensive and easy to deploy. An example of a recent success is the ice fence located upstream of a small hydro station on the island of Hokkaido in Japan. Ice nets caused the formation of an ice cover upstream of the Stornorrfor power station on the Ume river in Sweden, with surface velocities in the 3-ft/s range, well above the accepted maximum for booms of 2.3 ft/s. The

ice nets have the additional advantage of no depth limitation. Perhaps the nets could be used upstream of booms in borderline formation situations. Some adaptation of the ice net could possibly be used to stabilize and retain shore ice at locations downstream of peaking hydro dams as well.

**Applicability of structural ice control methods to river confluence situations**

A future phase of the work unit on structural ice control will evaluate various structural solutions at selected confluences. This section serves as a lead in, indicating which methods have potential in which applications. Table 1 ranks the applicability of selected structural ice control methods to five confluence situations. For the sake of simplicity, only the five major structure categories are considered:

- Floating booms;
- Shear booms;
- Man-made islands;
- Weirs and dams; and
- Piers and boulders.

The structure types are grouped according to function, i.e., freeze-up and breakup. They are further categorized as removable or fixed.

shear booms are not without potential. Perhaps floating ice could be diverted towards the shore or onto floodplains for storage, or directed away from navigation channels and fleeting areas on large rivers. Weirs and dams get high rankings in nearly all categories when dealing with both breakup and freeze-up ice problems. Finally, piers apply potentially to many confluence ice control situations, although, to date, they have been tested only on small to medium-sized rivers.

**Channel depth and water current velocity at selected structures**

As a final overview, the closing section of this report examines the range of existing structures with respect to river depth and velocity (Fig. 27, Table 2). The structures are divided into six groups according to type and function:

- Formation booms;
- Formation weirs;
- Tension weirs;
- Lines and nets;
- Pier breakup structures; and
- Weir and pier combinations.

For methods that significantly raise the water level, such as weirs and piers, velocities and

**Table 1. Applicability of structural ice control methods to river confluence situations.**

Confluence situation	Example	Freeze-up					Breakup	
		Removable			Fixed		Weirs and dams	Piers and boulders
		Floating booms	Shear booms	Man-made islands				
Large river–Large river	Mississippi–Missouri	3*	3*	3*		5	4*	
Small river–Large river	Oil Creek–Allegheny R.	5	1*	0		5	5*	
Large lake–Large river	Lake Erie–Upper Niagara R.	5	1*	4		0	4*	
Large river–Large lake	St. Lawrence R.–Lake St. Peter	5	1*	5		4	3*	
Small river–Lake	Czech Rivers–Reservoirs	0	0	0		4	5	

\* Indicates potential application, but not tried.

Scale:  
 0 1 2 3 4 5  
 not highly  
 applicable applicable

Floating booms, man-made islands, and weirs and dams apply well to relatively low velocity confluence situations where a stable ice cover is desired. Careful location of formation booms upstream of large river–large river confluences may reduce the ice supply to the main stem and the severity of resulting ice jam problems. Although never tried in confluence situations,

depths are given for the pool immediately upstream of the structure. The groups fall into somewhat distinct fields, as shown in Figure 27. Formation booms, the most common type of ice control structure, have the greatest range of application, particularly in terms of depth. For formation booms the maximum possible velocity is approximately 2.5 ft/s. The depth ranges from

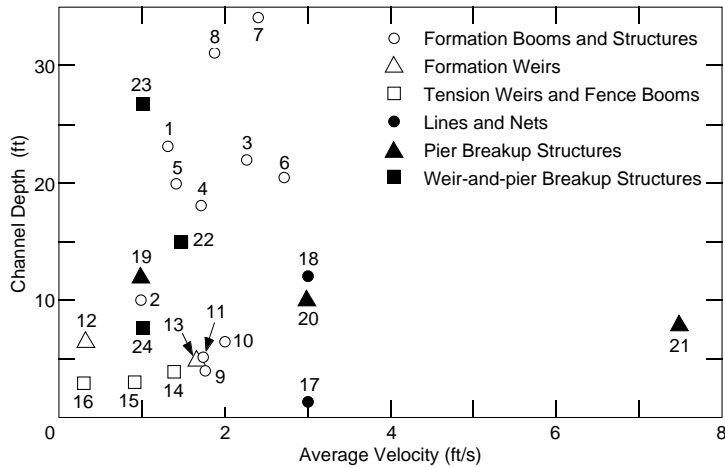

Figure 27. Depth vs. average velocity for various types of ice control structures. The numbers correspond to the list in Table 2.

4–5 ft for shallow pool–riffle rivers to 45 ft for some booms on major waterways such as the St. Lawrence. Slightly higher velocities are reported for the St. Marys River boom, which retains predominantly brash and floes rather than frazil.

The Montreal Harbor ICS and the Lake St. Peter ice islands, with similar hydraulic conditions, fall into the same field as the formation booms.

Formation weirs, like booms, promote ice cover growth during freeze-up, and their veloc-

Table 2. Channel depth and water current velocity at selected structures.

Structure	Depth (ft)			Velocity (ft/s)		
	low	high	average	low	high	average
<b>Formation booms and structures</b>						
1 Ice islands, Lake St. Peter	21	25	23	1	1.6	1.3
2 Booms at Lanoraie and Lavaltrie			10			1
3 Montreal Harbor ICS			22	2	2.5	2.25
4 Lake Erie boom			18	1.4	2	1.7
5 Lake St. Francis boom			20			1.4
6 St. Marys River boom	10	31	20.5			2.7
7 Beauharnois Canal booms			34			2.4
8 International Section booms	17	45	31	0.95	2.75	1.85
9 Salmon boom	2	6	4	1	2.5	1.75
10 Allegheny boom			6.4			2
11 North Platte boom			5			1.7
<b>Formation weirs</b>						
12 Israel River weir			6.5			0.33
13 Oil Creek weir			5	1.5	1.8	1.65
<b>Tension weirs and fence booms</b>						
14 Mascoma River fence boom			4.0			1.4
15 Japanese ice fence			3			0.9
16 Union Village tension weir			3			0.3
<b>Lines and nets</b>						
17 Frazil collector lines	1	4	2.5	2.4	3.6	3
18 Swedish ice nets			12			3
<b>Pier break-up</b>						
19 Credit River piers			12			1
20 Hardwick granite blocks			10			3
21 Mohawk River ice breakers			8	5	10	7.5
<b>Weir and pier</b>						
22 St. Raymond weir with piers			15	1	2	1.5
23 Ice control dam at St. Georges			27			1
24 Narragausus River structure			7.5			1

ity range is similar to formation booms. Formation weirs such as the Israel River and Oil Creek structures, with velocities in the 0.3- to 1.7-ft/s range, are limited to shallower rivers due to cost. Tension weirs built to date (including the Japanese ice fence) are even more limited in terms of depth but are comparable to fixed weirs in terms of approach flow velocity. Although experimental at this point, frazil collector lines and nets are relatively unconstrained by depth and appear to exceed the velocity range of formation booms and weirs, promoting ice cover growth with velocities in the 3-ft/s range.

Of the two groups of breakup structures, weirs with piers are the more conservative, with approach velocities in the 1.0- to 1.5-ft/s range. In addition, the weir breakup structures do not depend solely on arching and the formation of a grounded jam to impound flow and reduce the approach velocity. Note that, even at the peak discharges associated with breakup, the approach velocity is quite comparable to the surface velocities upstream of the formation boom group, indicating that the design of these breakup ice control weirs is quite conservative. The breakup structures that rely on piers alone to form a grounded jam appear less conservative in terms of approach velocity. At an extreme breakup flow, the calculated approach velocity for the recently completed Hardwick granite block structure is in the 3-ft/s range. The experimental structure performed well during its first winter of testing, however. Estimated velocities at the Colebrook, N.H., icebreaker blocks are high, 5–10 ft/s, and the adjacent floodplain conveyance area is limited. It is therefore not surprising that the structure fails to retain the breakup ice run.

In conclusion, the range of possible approach velocities for successful ice retention is relatively narrow. Figure 27 shows the practical upper limit for all groups of structures to be in the vicinity of 3 ft/s. In addition, there is considerable overlap in the velocity ranges of the formation boom, formation weir, pier breakup and weir-and-pier breakup structure groups. For the formation boom and frazil lines and nets groups, the velocity must fall into the range of less than or equal to 3 ft/s under natural conditions. The remaining four groups rely on some structural means of raising the water level to meet the velocity criteria, however.

## LITERATURE CITED

- Abdelnour, R., G. Comfort and R.D. Crissman** (1994) Assessment of ice boom technology for application to the upper Niagara River. In *Proceedings, IAHR Symposium on Ice, Trondheim, Norway, 23–26 August*. International Association for Hydraulic Research, p. 734–743.
- Ashton, G.D. (Ed.)** (1986) *River and Lake Ice Engineering*. Littleton, Colorado: Water Resource Publications.
- Assur, A. and G.F. Frankenstein** (1963) Control of ice jams at Colebrook, New Hampshire. USA Cold Regions Research and Engineering Laboratory Technical Memorandum, December, unpubl.
- Atkinson, C.H. and T.W. Waters** (1978) Ice regime at Churchill Falls, Labrador. A comparison of design expectations with actual performance. In *Proceedings, IAHR Symposium on Ice Problems, Luleå, Sweden, 7–9 August*. International Association for Hydraulic Research, Part 2, p. 165.
- Axelson, K.D.** (1991) Israel River ice control structure. In *Proceedings, 15th Annual Conference of the Association of State Floodplain Managers, Denver, Colorado, 10–14 June*, p. 349–352.
- Axelson, K.D., E.P. Foltyn, L.J. Zabilansky, J.H. Lever, R.E. Perham and G.E. Gooch** (1990) Salm-on River ice jam control studies. Interim Report. USA Cold Regions Research and Engineering Laboratory, Special Report 90–6.
- Belore, H.S., B.C. Burrell and S. Beltaos** (1990) Ice jam mitigation. *Canadian Journal of Civil Engineering*, 17(5): 675–685.
- Billfalk L.** (1984) Strategic hydro power operation at freeze-up reduces ice jamming. In *Proceedings, IAHR Ice Symposium, Hamburg, Germany*. International Association for Hydraulic Research, vol. 1, p. 265–275.
- Brachtl, I.** (1974) Ice control structures on Slovak Rivers. In *Proceedings, IAHR International Symposium on Rivers and Ice. Volume of General Information and Postprints*. International Association for Hydraulic Research, p. 149–153.
- Bryce, J.B.** (1982) A hydraulic engineering history of the St. Lawrence power project with special reference to regulation of water levels and flows. Prepared for Ontario Hydro, January, unpublished.
- Burgi, P.H.** (1971) Ice control structure on the North Platte River: A hydraulic model study. U.S. Department of the Interior, Bureau of Reclamation paper, REC-ERC–71–465.

- Burgi, P.H. and D.E. Krogstad** (1986) Ice management at Dickenson Dam Spillway crest gate. In *Proceedings, IAHR Ice Symposium, Iowa City, Iowa, 18–22 August*. International Association for Hydraulic Research, vol. 2, p. 235–247.
- Calkins, D.J.** (1984) Cold facts of ice jams, Part II: Case studies of mitigation methods. Paper presented at the 8th Annual Convention of Floodplain Managers, 11–15 June, Portland, Maine.
- Carstens, T.** (1992) Floating ice as a problem to hydropower intakes. In *Proceedings, IAHR Ice Symposium, Banff, Canada, 15–19 June*. International Association for Hydraulic Research, vol. 1, p. 104–113.
- Carstens, T. and E. Tesaker** (1987) Technical measures for reduction of ice damage. *Nordic Expert Meeting on River Ice, Espoo, Finland, 2–4 November*, p. 207–216.
- Civil Engineering** (1994) President Clinton honors federal design winners. July, p. 14.
- Crissman, R.D.** (1994) Ice jamming processes in the Upper Niagara River: An observational and analytical perspective. In *Proceedings, IAHR Symposium on Ice, 23–26 August 23–26, Trondheim, Norway*. International Association for Hydraulic Research, p. 674–683.
- Cumming-Cockburn and Associates Ltd.** (1986a) Ice jams on small rivers. Remedial measures and monitoring. 145 Sparks Avenue, Willowdale, Ontario M2H 2S5 Canada.
- Cumming-Cockburn and Associates Ltd.** (1986b) Mississauga ice control project. 145 Sparks Avenue, Willowdale, Ontario M2H 2S5 Canada.
- Deck, D.** (1984) Controlling river ice to alleviate ice jam flooding. In *Proceedings, IAHR Ice Symposium, Hamburg, Germany*. International Association for Hydraulic Research, p. 69–76.
- Deck, D. and G. Gooch** (1984) Performance of the Allegheny River ice control structure, 1983. USA Cold Regions Research and Engineering Laboratory, Special Report 84-13.
- Decsi, E. and G. Szepessy** (1988) Model studies on ice control structure. In *Proceedings, IAHR Ice Symposium, Sapporo, Japan, 23–27 August*. International Association for Hydraulic Research, vol. 2, p. 53–58.
- Donnelly, P.** (1966) Ice pressures on structures. National Research Council of Canada, Associate Committee on Geotechnical Research, Technical Memorandum No. 92, p. 171–184.
- Foltyn, E.P.** (1990) Laboratory and field tests of a wire mesh frazil collector. USA Cold Regions Research and Engineering Laboratory, Special Report 90–35.
- Freysteinnsson, S. and A. Benediktsson** (1994) Operation of hydro power plants under diverse ice conditions. In *Proceedings, IAHR Symposium on Ice, Trondheim, Norway, 23–26 August*. International Association for Hydraulic Research, vol. 2, p. 118–128.
- Gooch, G.E.** (in prep.) The effects of ice boom geometry on the capture efficiency. USA Cold Regions Research and Engineering Laboratory, Special Report.
- Gooch, G.E. and D. Deck** (1990) Model study of the Cazenovia Creek ice control structure. USA Cold Regions Research and Engineering Laboratory, Special Report 90–29.
- Gooch, G.E. and S.F. Daly** (in prep.) Oil City, Pennsylvania, ice management project: Ice control structures operations overview. Report to the Pittsburgh District.
- Grzes, M.** (1989) Some problems on the ice cover formation in the Wloclawek Reservoir. In *Proceedings Ice Seminar, Warsaw, Poland*.
- Imaizumi, A., F. Hara, K. Enoki and H. Saeki** (1993) Development of sink and float ice boom. In *Proceedings of the 8th International Symposium on Okhotsk Sea and Sea Ice, 1–5 February, Mobetsu, Hokkaido, Japan*.
- Jain, S.C., R. Ettema and I. Park** (1993) Flow regulation for controlled river ice formation. USA Cold Regions Research and Engineering Laboratory, CRREL Report 93-3.
- Kanavin, E.** (1970) Experience with ice problems in Pasvik River. In *Proceedings IAHR Ice Symposium 1970, Reykjavik, Iceland*. International Association for Hydraulic Research, Paper 4.7
- Lawrie, C.J.R.** (1972) Ice control measures on the St. Lawrence river. *Proceedings, Eastern Snow Conference, Oswego, New York*.
- Lever, J.H.** (1995) A low-cost breakup ice control structure. U.S. Army Cold Regions Research and Engineering Laboratory. Ice Engineering Information Exchange Bulletin.
- Michel, B.** (1971). Winter regime of rivers and lakes. USA Cold Regions Research and Engineering Laboratory, Cold Regions Science and Engineering Monograph 111-B1a, p. 114–118.
- Mineta, M., M. Yamazaki and K. Hirayama** (1994) A field study of ice control structure on river rapids. In *Proceedings, IAHR Symposium on Ice, Trondheim, Norway, 23–26 August*. International Association for Hydraulic Research, vol. 1, p. 139–148.
- Perham, R.E.** (1974) Forces generated in ice boom structures. USA Cold Regions Research and Engineering Laboratory, Special Report 200.

- Perham, R.E.** (1975) Some economic benefits of ice booms. In *Proceedings of the Second International Symposium on Cold Regions Engineering, University of Alaska, Fairbanks, 12–14 August 1976*, p. 570–591.
- Perham, R.E.** (1977) St. Marys River ice booms. Design force estimate and field measurements. USA Cold Regions Research and Engineering Laboratory, CRREL Report 77-4.
- Perham, R.E.** (1978) Ice and ship effects on the St. Marys River ice booms. *Canadian Journal of Civil Engineering*, **5**: 222–230.
- Perham, R.E.** (1981) Tests of frazil collector lines to assist ice cover formation. *Canadian Journal of Civil Engineering*, **8**: 442–448.
- Perham, R.E.** (1983) Ice sheet retention structures. USA Cold Regions Research and Engineering Laboratory, CRREL Report 83-30.
- Perham, R.E.** (1984) The effectiveness of the navigation ice booms on the St. Marys River. USA Cold Regions Research and Engineering Laboratory, CRREL Report 84-4.
- Perham, R.E.** (1985) Determining the effectiveness of a navigable ice boom. USA Cold Regions Research and Engineering Laboratory, Special Report 85-17.
- Perham, R.E.** (1986) Preliminary study of a structure to form an ice cover on river rapids during winter. In *Proceedings, IAHR Ice Symposium, Iowa City, Iowa*. International Association for Hydraulic Research, vol. 1, p. 439–450.
- Perham, R.E.** (1988) Inventory of ice problem sites and remedial ice control structures. USA Cold Regions Research and Engineering Laboratory, Special Report 88-7.
- Perham, R.E. and L. Raciot** (1975) Forces on an ice boom in the Beauharnois Canal. In *Proceedings, 3rd International Symposium on Ice Problems, Hanover, New Hampshire, 18–21 August*. International Association of Hydraulic Research, p. 397–407.
- Power Authority of the State of New York** (1970) Ice and power. Brochure.
- Roen, S. and E. Tasaker** (1988) Ice problems in intakes to power stations. In *Proceedings, IAHR Ice Symposium, Sapporo, Japan*. International Association for Hydraulic Research, vol. 2, p. 81–91.
- Saeki, H.** (1992) Ice control in northern harbors. In *Proceedings, IAHR Symposium on Ice, Banff, Canada*. International Association for Hydraulic Research, vol. 3, p. 1221–1241.
- Sahlberg, J.** (1990) Frazil ice problems at Stornorrfors Water Power Plant in the Ume River. In *Proceedings, IAHR Ice Symposium, Espoo, Sweden*. International Association for Hydraulic Research, vol. 1, p. 427–441.
- Solve, T.** (1986) Winter traffic on the Trollhatte Canal and Lake Vanern. In *Proceedings, IAHR Ice Symposium, Iowa City, Iowa*. International Association for Hydraulic Research, vol. II, p. 63–73.
- U.S. Army Corps of Engineers** (1985) Ice Engineering Manual. EM1110-2-1612, Department of the Army, Corps of Engineers, Office of the Chief of Engineers, Appendix B.
- Uzuner, M.S., J.J. Peter and D.C.N. Robb** (1977) Force measurement on a navigable ice boom. *Journal of the IAHR*, **15**(2): 179–187.
- White, K.D.** (1992) Salmon River experimental ice boom, 1989-90 and 1990-91 winter seasons. USA Cold Regions Research and Engineering Laboratory, Special Report 92-20.
- White, K.D. and J.E. Zufelt** (1993) Performance and evaluation of freeze-up ice jam control at Salmon, Idaho. Final Report to U.S. Army Engineer District Engineer, Walla Walla, Washington.
- Yamaguchi, T., H. Yoshida, N. Yashima and M. Ando** (1981) Field test study of “pack ice barrier.” In *POAC 81: Proceedings, 6th International Conference on Port and Ocean Engineering under Arctic Conditions, 27–31 July, Quebec, Canada*. Université Laval, p. 313–322.



## APPENDIX A: INVENTORY OF EXISTING STRUCTURES

Location	Structure type	Function*	Material	Size (ft)	Span (ft)	Force level (kips/ft) <sup>†</sup>	Water depth (ft)	Avg. water velocity (ft/s)	Organization	Performance and date of most recent information
St. Lawrence River, Lake St. Peter	Artificial islands Low	icfs, n, ijr	Stone (2.0–3.6 diam) glacial till	34 (diam at waterline) ~260 (diam at base) 8.2 (ht above low water)	2000		9–17	1.0–1.6	Canadian Coast Guard Ice Control Office Quebec City, Quebec	The islands, spaced several thousand feet apart, effectively retain the sheet ice cover on the sides of the navigation channel. Settlement is a major problem requiring large ongoing maintenance costs. Alternative designs are being considered (1994).
St. Lawrence River, Lake St. Peter	Artificial islands High	icfs, n, ijr	Stone, glacial till	35 (diam at waterline) ~244 (diam at base) 14 (ht above low water)	2000	unknown	21–25	1.0–1.6	Canadian Coast Guard Ice Control Office Quebec City, Quebec	Same as for low islands. Since 1985, five islands have been added to the south side of the channel. In 1993 the Canadian Coast Guard spent \$375,000 topping up the nine islands (1994).
St. Lawrence River, Lake St. Louis	Artificial islands	icfs, n	Quarry stone; armor stone	Square, 39 along side at waterline; 115 at base; 19 high		unknown	14.4		Seaway Transport Canada Cornwall, Ontario	Undergoing evaluation as of 1985.
St. Lawrence River, upstream of Lake St. Peter	Single timber and circular pontoon	icfs, ijr, n	Douglas fir and hollow steel	1.2 × 2.0 × 30 2.5 (diam) × 30 Two booms: 2300 and 3300 ft long	400	0.64 m	10	1.0	Canadian Coast Guard	Used in conjunction with icebreaking, surveillance and ice islands. Circular steel pontoons being tested are instrumented for force. Improved capture efficiency and lower cost (1994).
Montreal Harbor, St. Lawrence River	Piers	icfs, fijr, bijr, n	Reinforced concrete	Structure width 6700	88 O.C.	10 d	22	2.0–2.5	Canadian Coast Guard Ministry of Transport Montreal	Originally, steel pontoons floated in slots between the piers, sustaining occasional damage. The pontoons have now been removed since it was found that the piers alone retain the sheet ice cover upstream of Montreal Harbor (1994).
Trollhatte Canal, west coast of Sweden	Booms, dolphins, rock cribs, ice	icfs, ijr, n	Timber booms						Single organizational entity under the Swedish Government	Year-round traffic since 1974. Comprehensive ice control program includes ice breaking, ice flushing, lock bubble and heaters as well as airborne surveillance (1986).
Lake Erie, near entrance to upper Niagara River	Single timber	icfs, ijr, p	Douglas fir	1.2 × 1.8 × 30 8800 ft long	400	0.42 d to submerge, 0.17 m with 54-knot wind	18	≤ 2	New York Power Authority, Niagara Falls, N.Y. Ontario Hydro, Niagara Falls, Ontario	Generally works well; however, a combination of variable winter temperatures, moderate ice thickness and strong west wind can cause lake ice to overrun the boom, resulting in severe ice jams in the Upper Niagara River (1994).

\* icfs = ice cover formation and stabilization  
d = shear or diversion  
t = trash collection or diversion  
ijr = ice jam reduction  
bijr = breakup ice jam reduction  
x = experimental  
p = hydroelectric power  
n = navigation

† m = measured  
d = design criterion  
e = estimated from damage

Location	Structure type	Function*	Material	Size (ft)	Span (ft)	Force level (kips/ft) <sup>†</sup>	Water depth (ft)	Avg. water velocity (ft/s)	Organization	Performance and date of most recent information
Lake St. Francis	Single rectangular pontoon	icfs, p, n	Hollow steel	1.3 × 2.7 × 20 7800 ft long	200	1.1 d	20	1.4	Centrale Beauharnois, Hydro Quebec	Navigation opening allows for both ship passage during the formation period and ice cover growth in the Beauharnois Canal downstream. Since first installed in 1978, the boom has prevented late winter lake ice from entering the canal (1994).
St. Marys River, Sault Ste. Marie, Michigan	Single timber	icfs, n	Douglas fir	1.0 × 2.0 × 2.0	205 avg.	0.73 m	10–31	2.7	Detroit District, U.S. Army Corps of Engineers	250-ft-wide opening for navigation. The boom effectively prevents ice floes from entering Little Rapids Cut (1992).
Beauharnois Canal, St. Lawrence River	4 single and 2 double pontoons	icfs, p, n	Hollow steel	1.2 × 1.8 × 3.0 and 3.0 (dam) × 20 on 6-ft centers ~ 2000 ft long	400 118	3.20 m	34	2.4	Hydro Quebec, Beauharnois	The two most downstream booms are the double pontoon type. The other four timber booms have been replaced by rectangular steel pontoons, reducing maintenance costs (1994).
International Section, St. Lawrence River	6-timber booms	icfs, p, n	Douglas fir	1.2 × 1.8 3.0 total length of the six booms = 15,000 ft	400	0.58 m	17–49	0.95–2.75	New York Power Authority, Massena, N.Y. Ontario Hydro, Niagara Falls, Ontario	Have performed well, with very little alteration since the six booms were first installed in 1959 (1994).
Lacopie Lake, Churchill Falls Power Project, Labrador	Timber boom	icfs, p, ijr		1300 ft long			20	1.0	Churchill Falls Power Project	Boom performed better than anticipated in the initial design (1978).
Pasvic River, Norway	2 timber booms upstream and 1 double circular boom, connected	icfs, p	Wood and plastic pipe steel wire 2×4 timbers	500 long 2.0 (diam) × 250 long		unknown	10	3.0	Power plant, Hestefoss Norway	Used in conjunction with stone groins and wing dams. Designed by Norwegians, operated by the Russians. Little is known (1970).
Lule River, upstream of Vittjarv Power Station, northern Sweden	Timber	icfs, p, ijr		Total length: ~1200 ft 330-ft-wide Central opening					Swedish State Power Board	The central gap is closed once the downstream ice cover has progressed as far upstream as the boom. At times, border ice is freed below the boom to hasten upstream progression of the ice cover (1984).
Danube River, Dunakiliti Hrusov Reservoir, Czechoslovakia-Hungary border	Timber boom	icfs, p	Wood	Total width: ~2000	330					Unknown (1988).
Vistula River, Reservoir, Poland	Timber booms	icfs, ijr, p	Wood							Unknown (1989).

\* icfs = ice cover formation and stabilization

d = shear or diversion † m = measured

t = trash collection or diversion d = design criterion

ijr = ice jam reduction e = estimated from damage

bijr = breakup ice jam reduction

x = experimental

p = hydroelectric power

n = navigation

Location	Structure type	Function*	Material	Size (ft)	Span (ft)	Force level (kips/ft) <sup>†</sup>	Water depth (ft)	Avg. water velocity (ft/s)	Organization	Performance and date of most recent information
Salmon River, nine miles upstream of Salmon, Idaho	Multiple timber (Fig. 8)	icfs, ijr	Triple douglas fir timbers	1.0 × 1.0 × 20	260	0.66 d	2–6	1–2.5	CRREL	Experimental. Installed winters of 88–92. Capture efficiency optimized by moving right anchor 240 ft upstream, locating point of maximum sag in lower velocity area. Calculated benefit-to-cost ratio favorable (1994).
Allegheny River, Oil City, Penn.	Single pontoons	icfs, ijr	Rectangular foam-filled steel pontoons	1.3 × 2.7 × 20 total width: 525 ft	250	1.12 d	6.4	2.0	Pittsburgh District, U.S. Army Corps of Engineers	Promotes ice cover formation, reducing frazil accumulation at confluence with Oil Creek downstream. Success depends on flow control at upstream dam (1994).
North Platte River, upstream of Casper, Wyoming	Two single-timber boom in series	icfs, ijr	Timbers with steel spikes	1.2 × 1.7 × 12 steel spikes protruding 0.5 ft above and below, on 1.0-ft centers	200		5	1.7	Bureau of Reclamation	Prototype booms installed in 1968. Performed well until 1970. Bureau of Reclamation personnel in Mills, Wyoming, have no present knowledge of the booms, so it is likely that they are no longer installed (1994).
Sea of Okhotsk, harbor entrance, Hokkaido, Japan	Sink-and-float ice boom	Prevents pack ice from entering harbor	Teardrop-shaped section resists burial by sediment while resting on seabed.	~ 300 × 2 × 30 spans ~ 300-ft gap between breakwaters	~ 300				Nashimura-Gumi Co. Ltd.	Pontoons are sunk in the non-ice season, or to allow for vessel transits. They are refloated by injection of compressed air (1993).
Pasvic River, northern Norway	Stone groins	icfs, p	Stone jetties	13 wide, 3.9 above water surface; 100–200 long			4–6	3	Water Resources Electricity Board, Oslo, Norway	Used in conjunction with timber and plastic pipe booms. Designed by Norwegians. Operated by the Russians. Little known (1970).
Burntwood River, Thompson, Manitoba	Stone groins	icfs, p	Stone and earth wing dikes (opposing groins)	300 (max ht), 900 length 3.0–4.0 (diam of nose armor boulders)			23	< 19	Manitoba Hydro, Winnipeg	River flow increased by diversion. Groins used to raise pool and reduce velocity upstream allowing stable ice cover to form behind boom (1977).
Mississippi River	Bendway weirs	Maintain dredged navigation channel	Quarried rock	1000–2000 long ~ 50 high			deep	~ 5	St. Louis District, U.S. Army Corps of Engineers	Work well in their open channel objective of reducing dredging costs. Their effect on ice has not been evaluated (1994).
Chaudiere River, St. Georges, Quebec	Ice control dam	ijr, icfs	Reinforced concrete dam. Steel-grated gate openings.	42-ft-high × 620-ft-wide	20-ft-wide gates		27	slow	Quebec Ministry of Environment and Forests	The structure has fulfilled its design intent of eliminating the historically severe ice jam problem at St. Georges (1994).
Israel River, Lancaster, N.H.	Ice control weir	ijr, icfs	Concrete-capped, rock-filled gabion	6 ft high × 170 ft wide	4-ft sluice ways		6.9	< 0.33 in pool	New England District, U.S. Army Corps of Engineers	The Town of Lancaster has experienced no serious ice jam floods since the weir was built in 1980 (1994).

\* icfs = ice cover formation and stabilization

d = shear or diversion

t = trash collection or diversion

ijr = ice jam reduction

bijr = breakup ice jam reduction

x = experimental

p = hydroelectric power

n = navigation

† m = measured

d = design criterion

e = estimated from damage

Location	Structure type	Function*	Material	Size (ft)	Span (ft)	Force level (kips/ft) <sup>†</sup>	Water depth (ft)	Avg. water velocity (ft/s)	Organization	Performance and date of most recent information
Oil Creek, Oil City, Penn.	Weir with piers	icfs, ijr	Reinforced concrete	5 ft high × 351 ft wide, five ice piers. One 45-ft-wide Bascule gate.	piers 45 ft apart		5	1.5–1.8	Pittsburgh District, U.S. Army Corps of Engineers	Has performed well to date, promoting the formation of an ice cover which prevents the transport of frazil to problem locations downstream. The boom upstream of the structure is no longer installed (1994). Performed well. Scour problems pointed to the need for bed protection (1986). Since first installed in 1991, power interruptions due to frazil at intakes have been eliminated (1994). Performed well during 1992–94 field demonstration seasons. Mid-winter breakups caused collapse of weir and loss of pool, however. Limited weir height may require installation of weirs in series. Problems with debris and silt deposition behind weir.
Mascoma River, Lebanon, N.H.	Experimental fence boom	icfs, ijr	Wood 2×4s, wire rope	4.0 ft high, 0.3-ft gaps	54	0.80 d	1.3–1.6	1.4	CRREL	
Penkeniuppi River, Hokkaido, Japan	Free-standing ice fence	icfs, p	Wood 2-in. × 2-in. on steel frames	3.3 ft high, 2.8-in. gaps inclined 60° away from flow	90		3.3	1–3	Hokkaido Electric Power Co.	
Ompompanoosuc River, Union Village, Vermont	Experimental tension weir	icfs, fijr	Wire mesh net Wire rope main cable Vertical pole supports Geotextile Concrete tile and riprap bed protection	0.04 (diam) × 0.8 spacing 1.25 (diam) 60 kip 0.17 (diam) 0.03 thick 2.0 × 2.0 × 0.8 1.5–3.0 first blast	60	hydro-static 0.028 d	3.0	0.3 d	CRREL	
Ottawaquechee River, Quebec, Vermont	Experimental collector lines	icfs	Braided nylon rope	50 ft long, spaced at 0.5 ft	16	0.005–0.008 s	1.0–1.6	2.4–3.6	CRREL	Method never got past the experimental phase. Tangling problems.
Ume River, Stormorfors Power	Experimental ice nets for frazil collection.	icfs, p	Four nylon rope nets	0.20 in nylon rope 6-in. squares attached to a 0.63-in. span cable	~ 300 ft	0.10 d	~12	~ 3.3	SMHI, Norrköping, Sweden	Difficult to assess performance after one season of observations (1989–90).
Lamoille River, Hardwick, Vermont	Tire booms	bijr	Used truck tires Used ski lift cable	1.9-in.-diam	120	< 2 e anchors fail	6	3–4 at breakup	Town of Hardwick, Vt.	The booms, located 1 and 1.5 miles upstream of town, temporarily retain the breakup ice run until falling at the anchors. This allows time for mechanical removal of ice at downstream locations, reducing the ice jam threat (1994).
Credit River, Mississauga, Ontario		bijr	Reinforced concrete	1.6 wide, tops 1.5 above 1.5-year flood level	6.6	for 200 psi, 10-ft-thick ice	0–12	as high as 10 at the piers; 1.0 in pool	Credit Valley Conservation Authority	No serious ice jam damage downstream since completion in 1988. Scour damage where floodplain flow re-enters main channel downstream of piers. Requires debris removal (1994).
Lamoille River, Hardwick, Vermont	Granite boulders	bijr	Four quarried granite blocks Riprap bed and bank protection	6 ft high × 4.5 ft wide First blast < = 2 ft	14		15 d	~3 d upstream	CRREL, Town of Hardwick	Installed Sept 1994. No field observations to date.
Mohawk River, Colebrook, N.H.	Blocks or "ice-breakers"	bijr	Three poured-in-place concrete	8 ft high × 8 ft wide channel width: 70 ft	~ 20		8	~ 10		~ 50 years old. Does not completely stop the ice run. A field inspection in 1994 found ice debris piled to block height behind the right two blocks, however.

\* icfs = ice cover formation and stabilization  
d = shear or diversion  
t = trash collection or diversion  
ijr = ice jam reduction  
bijr = breakup ice jam reduction  
x = experimental  
p = hydroelectric power  
n = navigation

† m = measured  
d = design criterion  
e = estimated from damage

Location	Structure type	Function*	Material	Size (ft)	Span (ft)	Force level (kips/ft) <sup>†</sup>	Water depth (ft)	Avg. water velocity (ft/s)	Organization	Performance and date of most recent information
Hnilec and Vah Rivers, Czechoslovakia	Steel piles break up ice-control structures	bjir	8-in.-diam. concrete-filled steel pipe	10-ft-high tops roughly level with floodplain; widths range from 130 to 400 ft	6.6		~ 13		Water Research Institute, Bratislava, Czechoslovakia	The structures were built in the late 60s and 70s. Their performance was described as "adequate and efficient" in 1974.
Riviere Ste. Anne, St. Raymond, Que.	Weir with piers	bjir, icfs	Reinforced concrete, riprap bed and bank protection	15-ft-high weir, piers rise 6 ft above crest Widths: ~260 ft	piers 20 ft apart		15	1-2 e	Quebec Ministry of Environment and Forests	Has performed well since completion of the structure in 1980 (1994).
Narragausus River, Cherryfield, Maine	Timber crib dam with "icebreaker" piers upstream	icfs, bjir	Rock-filled timber Crib piers	7-ft-high weir 140 ft wide Central spillway	piers ~ 50 ft apart	5.0 d	7.5	1	New England District, U.S. Army Corps of Engineers	No significant ice jam flooding in Cherryfield since the structure was built in 1961.
Tungnaa River, Sigalda Reservoir	Fixed boom Spillway barrier	Ice retention during extreme runoff events, p	Reinforced concrete	18 ft high with flashboards 8.2 × 360	d	10.0	20-21	≤ 16	Landsvirkjun (National Power Company) Reykjavik, Iceland	Designed to retain ice during floods at an emergency overflow spillway. No floods have occurred since construction in 1977, however (1994).
Heart River, Dickenson Dam Spillway, N.D.	Timber boom	Ice retention upstream of crest gate	Douglas fir	1.3 × 1.7 × 20 1.13 in main cable	150	Designed to withstand 100-year	8		Bureau of Reclamation	Designed and built in response to ice damage to the crest gate in 1982. Has worked well since (1994).
Saroma Lagoon, Sea of Okhotsk, Japan	Four-legged pack ice barrier	Protect shorelines from pack ice	Ballasted steel pipe	22-in.-diam steel pipe units 19 ft high, 33 ft long		1.1 d	13		Mitsui Engineering and Shipbuilding Co., Ltd.	Performed well during field tests, 1979-1980. Withstood typhoon. Successful performance reported in 1992.
Tungnaa River, Hrauneyfjoss Power Station	Shear boom	d, prevent frazil from entering intakes	Reinforced concrete	26 × 20 × 1974.0 d 23-30		4.0 d	23-30		Landsvirkjun (National Power Company), Reykjavik, Iceland	The boom effectively prevents frazil from entering the intake canal. Enough frazil is generated in the canal itself to cause blockages at the intakes, however (1994).
Columbia River, Chief Joseph Dam, Bridgeport, Wash.	Shear boom	d, mainly debris	Concrete-ballasted hollow circular steel pontoons	228 6-ft-diam × 12-ft-long government surplus ship mooring floats	1685 and 1853 spans	103 d on main anchor	~ 50-100	2	U.S. Army Engineer District, Seattle, Washington	Installed in 1980, at a cost of \$1,245,000. Projected savings: \$297,000/yr. No recent information.

\* icfs = ice cover formation and stabilization  
d = shear or diversion  
t = trash collection or diversion  
bjir = ice jam reduction  
bjr = breakup ice jam reduction  
x = experimental  
p = hydroelectric power  
n = navigation  
† m = measured  
d = design criterion  
e = estimated from damage

# REPORT DOCUMENTATION PAGE

Form Approved  
OMB No. 0704-0188

Public reporting burden for this collection of information is estimated to average 1 hour per response, including the time for reviewing instructions, searching existing data sources, gathering and maintaining the data needed, and completing and reviewing the collection of information. Send comments regarding this burden estimate or any other aspect of this collection of information, including suggestion for reducing this burden, to Washington Headquarters Services, Directorate for Information Operations and Reports, 1215 Jefferson Davis Highway, Suite 1204, Arlington, VA 22202-4302, and to the Office of Management and Budget, Paperwork Reduction Project (0704-0188), Washington, DC 20503.

1. AGENCY USE ONLY (Leave blank)		2. REPORT DATE <b>July 1995</b>		3. REPORT TYPE AND DATES COVERED	
4. TITLE AND SUBTITLE  <b>Structural Ice Control: Review of Existing Methods</b>				5. FUNDING NUMBERS  <b>WU 22926</b>	
6. AUTHORS  <b>Andrew M. Tuthill</b>					
7. PERFORMING ORGANIZATION NAME(S) AND ADDRESS(ES)  <b>U.S. Army Cold Regions Research and Engineering Laboratory 72 Lyme Road</b>				8. PERFORMING ORGANIZATION REPORT NUMBER  <b>Special Report 95-18</b>	
9. SPONSORING/MONITORING AGENCY NAME(S) AND ADDRESS(ES)  <b>Office of the Chief of Engineers Washington, D.C. 20314-1000</b>				10. SPONSORING/MONITORING AGENCY REPORT NUMBER	
11. SUPPLEMENTARY NOTES					
12a. DISTRIBUTION/AVAILABILITY STATEMENT  <b>Approved for public release; distribution is unlimited.</b>  <b>Available from NTIS, Springfield, Virginia 22161.</b>				12b. DISTRIBUTION CODE	
13. ABSTRACT ( <i>Maximum 200 words</i> )  <b>This report is a comprehensive review of structural ice control methods in use worldwide today. The structures are grouped according to the purpose of the ice control. Categories are sheet ice retention, breakup ice control and ice diversion. The focus is on the recent performance of the structures. Innovative solutions that could be applied to river confluence ice problems also receive special attention. The report reviews the state of the art in structural ice control, addressing the ranges as well as the limits of application of methods in use today.</b>					
14. SUBJECT TERMS  <b>Ice control                      Ice jams Ice control structures      River ice</b>				15. NUMBER OF PAGES <b>38</b>	
				16. PRICE CODE	
17. SECURITY CLASSIFICATION OF REPORT  <b>UNCLASSIFIED</b>		18. SECURITY CLASSIFICATION OF THIS PAGE  <b>UNCLASSIFIED</b>		19. SECURITY CLASSIFICATION OF ABSTRACT  <b>UNCLASSIFIED</b>	
				20. LIMITATION OF ABSTRACT  <b>UL</b>	